



# Shimmer User Manual

Revision 3p

## Legal Notices and Disclaimers

### Disclaimers

REALTIME TECHNOLOGIES LTD. MAKES NO WARRANTY OF ANY KIND WITH REGARD TO THIS MATERIAL, INCLUDING, BUT NOT LIMITED TO, THE IMPLIED WARRANTIES OF MERCHANTABILITY AND FITNESS FOR A PARTICULAR PURPOSE. REALTIME TECHNOLOGIES LTD. ASSUME NO RESPONSIBILITY FOR ANY ERRORS THAT MAY APPEAR IN THIS DOCUMENT. REALTIME TECHNOLOGIES LTD. MAKES NO COMMITMENT TO UPDATE NOR TO KEEP CURRENT THE INFORMATION CONTAINED IN THIS DOCUMENT.

THIS SPECIFICATION IS COPYRIGHTED BY AND SHALL REMAIN THE PROPERTY OF REALTIME TECHNOLOGIES LTD. NO LICENSE, EXPRESS OR IMPLIED, BY ESTOPPEL OR OTHERWISE TO ANY INTELLECTUAL PROPERTY RIGHTS IS GRANTED HEREIN.

REALTIME TECHNOLOGIES LTD. DISCLAIM ALL LIABILITY, INCLUDING LIABILITY FOR INFRINGEMENT OF ANY PROPRIETARY RIGHTS, RELATING TO USE OF THE MATERIALS AND IMPLEMENTATION OF INFORMATION IN THIS SPECIFICATION. INTEL DO NOT WARRANT OR REPRESENT THAT SUCH USE OR IMPLEMENTATIONS WILL NOT INFRINGE SUCH RIGHTS.

NO PART OF THIS DOCUMENT MAY BE COPIED OR REPRODUCED IN ANY FORM OR BY ANY MEANS WITHOUT PRIOR WRITTEN CONSENT OF REALTIME TECHNOLOGIES LTD.

REALTIME TECHNOLOGIES LTD. RETAINS THE RIGHT TO MAKE CHANGES TO THESE SPECIFICATIONS AT ANY TIME, WITHOUT NOTICE.

### CAUTION

**RISK OF EXPLOSION IF BATTERY IS REPLACED BY AN INCORRECT TYPE.**

**DISPOSE OF USED BATTERIES ACCORDING TO THE INSTRUCTIONS.**

### Legal Notices

Realtime Technologies Ltd. software products are copyrighted by and shall remain the property of Realtime Technologies Ltd. Use, duplication or disclosure is subject to restrictions stated in the three clause BSD license, or in the case of software delivered to the government, in accordance with the software license agreement as defined in FAR 52.227-7013. The Shimmer logo is a registered trademark of Realtime Technologies Ltd.



Other brands, marks and names mentioned herein may be the property of their respective owners and used in accordance with published guidelines.

© REALTIME TECHNOLOGIES LTD. 2008-2017, All Rights Reserved

## Informed Consent Statement

Shimmer is an open flexible platform intended for qualified personal conducting research in wearable sensor applications. Consequently, although great care was taken in the design of this device, there is some inherent risk both with the design and manufacturing that you assume when the device is in close proximity to your body or the body of your test subjects. Depending on local regulations, Shimmer may not fully comply with commercial product testing standards. Shimmer as sold lacks medical certifications (e.g. ANSI/AAMI/IEC). Shimmer devices should never be used for diagnostic purposes without full consideration of operator and subject risk. The following list describes some of the subject risks:

- There is a risk of electrical shock due to manufacturing defects or improper use (see usage guidelines and warnings).
- There is also a risk of sustaining a burn due to a catastrophic failure of the device which could result from overheating of components.
- There is a risk of radio interference with the operation of other electronic devices and we make no claims to the consequences of this.
- There is a risk of some minor skin irritation from electrode pads over prolonged periods of time which may cause discomfort.
- The device is not designed with proper safeguards for defibrillation. As such, electrodes must be removed before defibrillation is attempted.

Data privacy limitations: It should be understood from the outset and you should communicate to test subjects that the physiological data that is streamed, stored, and analyzed through use of the device is not anonymized or privacy-protected in any way and you should take appropriate precautions in the protection and handling of such data in your research activities. Shimmer itself may buffer raw physiological data unencrypted on the integrated flash memory device. RF data streaming from the Shimmer may not be encrypted and could be intercepted by others. RF data downstream from an aggregation device, such as a cell phone may not be encrypted and is likewise susceptible to access.

Physiological data generated through use of Shimmer may indicate conditions that your test subject was previously unaware of prior to participation in research using the device.

There may be a risk of exposure to minute amounts of chemicals from the manufacturing process or the components themselves (such as latex, lead etc.).

There may be an increased risk of physical injury by the physical presence of the device on a test subject's body and you fully assume this responsibility.

**Realtime Technologies Ltd is not liable for damage or loss of data when using the Shimmer platform.**

Some Shimmer peripherals rely on 3rd party driver support. Whilst Realtime/Shimmer Research have tested features using a typical system, in some cases the end user will need to contact the peripheral vendor for resolution of installation, compatibility or operational issues.

By your use of Shimmer you acknowledge these and other risks inherent in the use of an experimental device and you assume full responsibility for testing this device with human subjects.

This device cannot be marketed or put into service within the EU until it has been made to comply with the Medical Devices Directive 93/42/EEC. In the United States, Shimmer is an investigational device, limited by US law to investigational uses.

## Agency Compliance

### FCC

Contains FCC ID: X2W-SR7-1

The FCC ID marking label is attached to the back of the Shimmer and is to remain attached at all times to comply with FCC requirements for Modular approval:

Here is an example of the text on the FCC ID marking label:

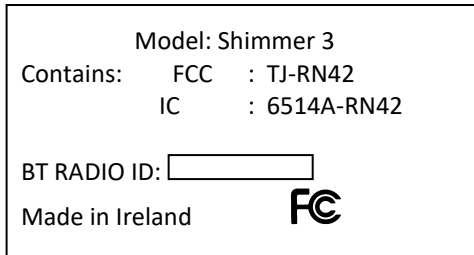

This device complies with Part 15 of the FCC Rules.

Operation is subject to the following two conditions:

- (1) This device may not cause harmful interference, and
- (2) This device must accept any interference received, including interference that may cause undesired operation.

#### RADIO AND TELEVISION INTERFERENCE

This equipment has been tested and found to comply with the limits for a Class B digital device, pursuant to Part 15 of the FCC rules. These limits are designed to provide reasonable protection against harmful interference in a residential installation. This equipment generates, uses, and can radiate radio frequency energy and, if not installed and used in accordance with the instructions, may cause harmful interference to radio communications. However, there is no guarantee that interference will not occur in a particular installation. If this equipment does cause harmful interference to radio or television reception, which can be determined by turning the equipment off and on, the user is encouraged to try to correct the interference by one or more of the following measures:

- Reorient or relocate the receiving antenna.
- Increase the separation between the equipment and the receiver.
- Connect the equipment into an outlet on a circuit different from that to which the receiver is connected.
- Consult the dealer or an experienced radio/TV technician for help.

Changes and Modifications not expressly approved by Realtime Technologies Ltd. can void your authority to operate this equipment under Federal Communications Commission rules.

### ICES-003 Label

This Class (\*) digital apparatus complies with Canadian ICES-003  
Cet appareil numérique de la classe (\*) est conforme à la norme  
NMB-003 du Canada

(\*) Insert either "A" or "B" but not both as appropriate for the  
equipment requirements

## Welcome Message

Thank you for your purchase of Shimmer!

This User Manual will provide essential operating instructions and help you to understand the capabilities of the Shimmer3 platform. Please note that the User Manual for the Shimmer2r platform (and previous) is available for download from our website, [www.shimmersensing.com](http://www.shimmersensing.com). The latest version of this manual is also available for download from our website.

In addition to the *Shimmer User Manual*, your Shimmer kit ships with the *Shimmer User Resources* distribution USB. It is recommended that you browse the contents of the *Shimmer User Resources* by initially opening the README file in your web browser and following the appropriate links. Updated versions of the items in the *Shimmer User Resources* may also be available for download from the [Shimmer website](http://www.shimmersensing.com).

If you have queries or need information in addition to that outlined in this document, it is recommended that you consult with our additional documentation, which is included in the *Shimmer User Resources* distribution and is available for direct download from our website. The website also contains an extensive FAQ section which may help to clarify any issues you might have. Also, check out the large number of tutorial videos on YouTube which can be found by search for 'Shimmer Sensing'. Should you have further queries you can contact our support service or use the Shimmer-users mailing list.

[info@shimmersensing.com](mailto:info@shimmersensing.com)

(non-technical questions)

[www.shimmersensing.com/support/wearable-sensing-support](http://www.shimmersensing.com/support/wearable-sensing-support) (technical questions)

[www.shimmersensing.com](http://www.shimmersensing.com)

(Shimmer website)

Best wishes,

The Shimmer Team

## Table of Contents

<b>Legal Notices and Disclaimers</b> .....	<b>i</b>
<b>Informed Consent Statement</b> .....	<b>ii</b>
<b>Agency Compliance</b> .....	<b>iii</b>
<b>Welcome Message</b> .....	<b>iv</b>
<b>Table of Contents</b> .....	<b>v</b>
<b>1. Introduction</b> .....	<b>1</b>
<b>2. Quickstart</b> .....	<b>2</b>
2.1. Powering On/Off the Shimmer.....	2
2.2. LogAndStream LED Indication .....	2
2.3. Charging the Shimmer .....	4
2.4. Pairing a Shimmer.....	4
2.5. Setting up a Shimmer data stream.....	7
<b>3. Shimmer3 Platform Overview</b> .....	<b>14</b>
3.1. Components .....	14
3.2. Shimmer Dock.....	18
3.3. Consensys Base.....	24
3.4. Other Accessories and Shimmer Platform Components .....	25
3.5. Maintenance.....	27
<b>4. Software</b> .....	<b>30</b>
4.1. Software Applications.....	30
4.2. Software Development.....	37
<b>5. Firmware</b> .....	<b>39</b>
5.1. Firmware Solutions.....	39
5.2. Programming a Shimmer .....	44
5.3. Firmware Development.....	47
<b>6. Hardware</b> .....	<b>49</b>
6.1. Shimmer Hardware Overview .....	49
6.2. Hardware Sub-System Detail.....	49

---

<b>7. Troubleshoot .....</b>	<b>55</b>
<b>8. References.....</b>	<b>57</b>
<b>9. Appendices.....</b>	<b>58</b>
9.1. Appendix A - Mainboard detail for Debug and Testing.....	58
9.2. Appendix B - Legacy Support.....	64
9.3. Appendix C – Opening or assembling the <i>Shimmer3</i> enclosure.....	64
<b>Glossary.....</b>	<b>68</b>

## 1. Introduction

Shimmer is a small wireless sensor platform well suited for wearable applications. The integrated kinematic sensors, large storage and low-power standards based communication capabilities enable emerging applications in motion capture, long-term data acquisition and real-time monitoring.

Shimmer3, the latest revision of the Shimmer platform includes improvements to the original design based on years of field trials and deployments. We have made improvements in wearability while expanding capabilities with a flexible kinematic sensor array, more powerful CPU and improved user interface. The terms 'Shimmer' and 'Shimmer3' are used interchangeably in this manual, to refer to the Shimmer3 device. Much of the information applies generically to Shimmer Products.

If you are new to the Shimmer platform, there is *Quickstart* information in *Section 2*, whilst *Section 3* gives a high level overview of the Shimmer platform. *Section 2 (Quickstart)* is essential reading, *Section 3 (Shimmer Platform Overview)* is recommended reading and the remaining sections are best browsed based on personal interest and development goals. For details on legacy devices please refer to *Shimmer Clock Drift*

*Like many* embedded devices, the clock on the Shimmer device is prone to drift. Laboratory experiments have indicated that Shimmer-to-Shimmer clock drift is variable and can be up to 12  $\mu\text{s/s}$ . To equate this to longer recording periods 12 $\mu\text{sec/sec}$  is equivalent to 0.72 ms/min, 43 ms/hour and 1.04 s/day.

Appendix B - Legacy Support.



## 2. Quickstart

The *Support > Getting Started* section of the Shimmer website contains step-by-step instructions for new Shimmer users to help with quickly going from delivery of hardware to streaming data over Bluetooth to a Windows PC or an Android device. It is highly recommended for new customers to refer to those instructions.

This *Quickstart* guide is aimed at those who do not have access to the online instructions and its purpose is to allow those users to swiftly get up and running with their Shimmer sensing platform on both a Windows OS and Linux OS. For a more in depth understanding of the Shimmer platform please refer to the later sections of this User Manual.

Shimmer units are shipped pre-programmed with the *LogAndStream* firmware program which allows for Shimmer configuration and data capture over Bluetooth as well as capturing data onto the SD card of the Shimmer. This *Quickstart* guide assumes the device has been programmed with *LogAndStream v0.8.0* or later.

### 2.1. Powering On/Off the Shimmer

Use the slide switch to turn the Shimmer On/Off, as shown in Figure 2-1. Some applications may use the user push-button to switch between suspend and active modes; details of this functionality can be found in the appropriate application manual.

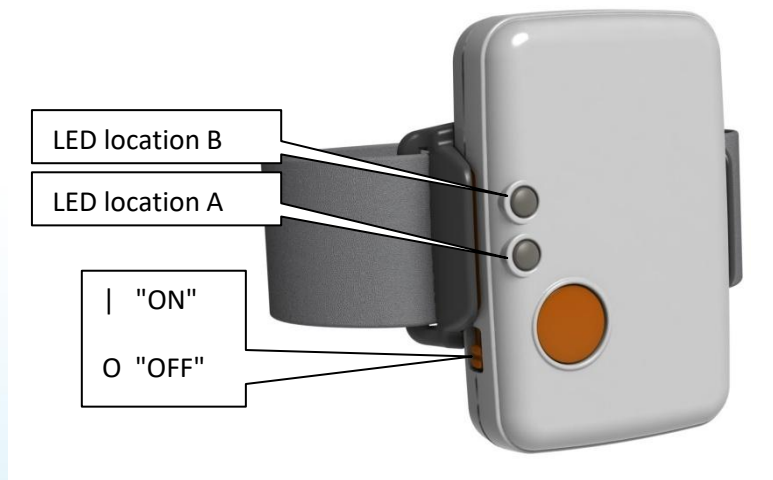

Figure 2-1 Shimmer3 in enclosure

### 2.2. LogAndStream LED Indication

There are two LED locations on the Shimmer3, as shown in Figure 2-1; location A has three LEDs, coloured red, yellow and green, whilst location B has two LEDs, coloured blue and green. These LEDs are used to indicate the state of the device, according to the firmware that is programmed on it.

Figure 2-2 and Figure 2-3 provide a summarised translation of LED behaviour when *LogAndStream* is running on the Shimmer (for a full *LogAndStream* LED translation table refer to *Section 5.1.1*). The relative size of the LED symbols in the figures denotes how long the LED of the relevant colour is on or off for, in each case.

		LED Pattern	Description
Docked or in Multi Charger	Full Charge		Green Solid ON
	Charging		Yellow Solid ON
Undocked	Full Charge		Green 0.1s ON/5s OFF
	Medium Charge		Yellow 0.1s ON/5s OFF
	Low Charge		Red 0.1s ON/5s OFF

Figure 2-2 LED indicators for LogAndStream (Location A)

		LED Pattern	Description
Docked or Undocked	Standby		Blue 0.1s ON/2s OFF
	Bluetooth Connected		Blue Solid ON
	Streaming only		Blue 1s ON / 1s OFF
	RTC not set		0.1s Blue/0.1s Green
Undocked only	Configuring		Green 0.1s ON/ 0.1s OFF
	SD error		0.1s Red/0.1s Yellow
	Logging only		Green 1s ON / 1s OFF
	Streaming and Logging		1s Blue/1s Green

Figure 2-3 LED indicators for LogAndStream (Location B and A)

**Note:** The above SD error LED sequence is present in LogAndStream\_v0.8.0 and later. Older versions of LogAndStream couple both SD and RTC errors into a 0.1s Blue/0.1s Green LED flashing sequence.

## 2.3. Charging the Shimmer

A Shimmer unit may be charged using a Shimmer Dock, Multi Charger, a Shimmer charging cable or a Consensus Base. This section is limited to the description of the *Shimmer Dock* (referred to as "the Dock" in the following) for charging purposes only. For a full description of the Dock functionality and charging with the *Shimmer Multi Charger* please refer to the *Shimmer3 Platform Overview* section of this document or the individual User Guides for these items.

Connect the *Dock* to a powered USB socket.

**Warning:** If you connect the Dock to a PC, do not allow Windows to install the driver automatically, as some versions of Windows (typically old than Windows 10) will not install the correct driver<sup>1</sup>. Driver installation is not required for charging purposes. For further details on driver installation please refer to the full description of the *Shimmer Dock* in the *Shimmer3 Platform Overview* section.

If using a single Shimmer Dock, insert the *Shimmer3* unit into the dock with the Bluetooth ID label facing away from the USB cable.

**Warning:** Forcing the connector may cause permanent damage to your Shimmer. If you have difficulty inserting the unit into the dock, check that you have the correct orientation.

A detailed explanation of the charging process is outlined in the Section 3.2.3 of this document.

If the Shimmer is powered on, when a charging source is available, the Shimmer will indicate charge status using the Battery status LEDs on the device; while the Shimmer is charging, the yellow LED will be on and once the battery is full, a green LED will be on.

## 2.4. Pairing a Shimmer

In order to capture data from a Shimmer sensor using a Bluetooth connection, the Bluetooth connection must first be set up in a process called *Pairing*. Two pairing procedures are outlined below: one for a Windows operating system and another for a Linux operating system. You should follow the procedure which applies to the OS you are using.

**Note:** The host side machine must have a plug-in or built-in Bluetooth radio installed and activated to continue.

### 2.4.1. Bluetooth Pairing in Windows

To pair the Shimmer (or any Bluetooth device) with a Windows OS, ensure that the unit is powered on and follow the steps below.

#### **View Devices**

In order to view the list of devices connected to the PC already, follow the path *Control Panel* → *Hardware and Sound* → *Devices and Printers*. A window similar to Figure 2-4 containing a list of devices is presented. Both Bluetooth devices and non-Bluetooth devices are shown.

---

<sup>1</sup> Note that Windows 7 has been found to install the correct driver.

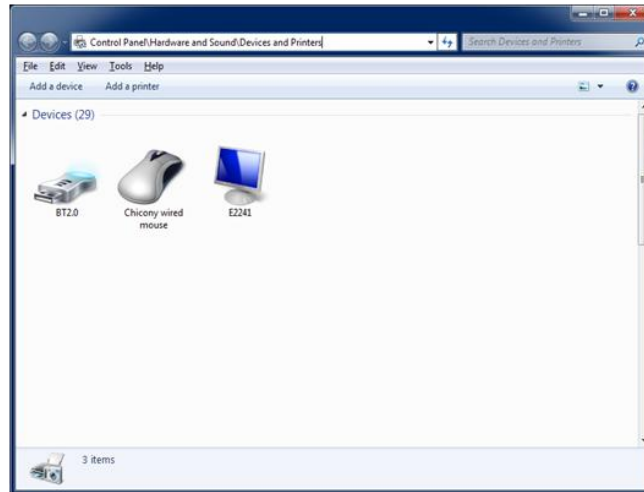

Figure 2-4 View Devices and Printers

### Search for Shimmer Devices

To add a Shimmer to the list of devices connected with the PC, select the *Add a Device* button on the top left of the window (see screenshot on left of Figure 2-5). Windows will now search for Bluetooth devices that are within range of your PC's BT radio and display them as in the screenshot on the right of Figure 2-5.

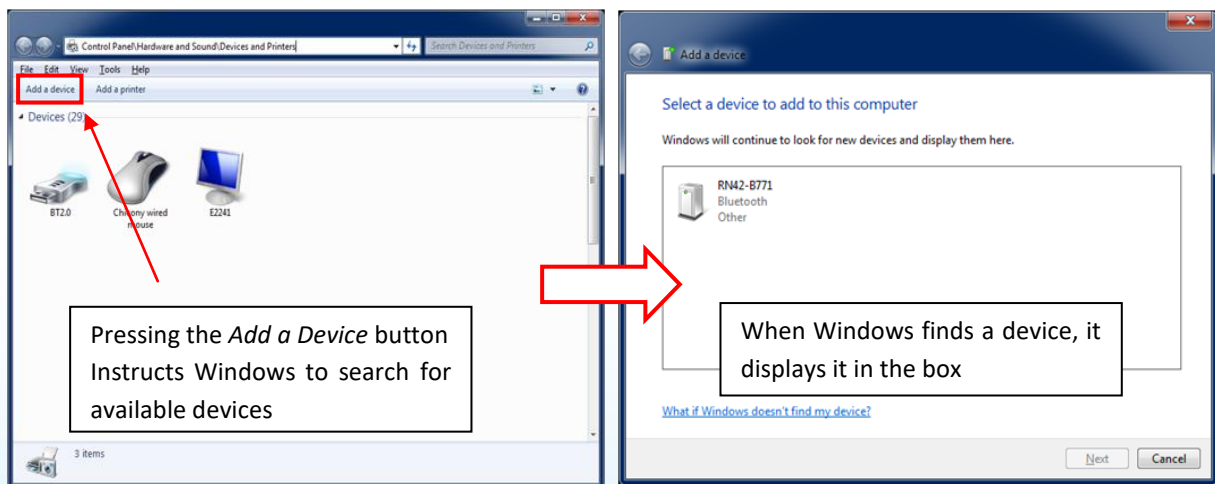

Figure 2-5 Searching for available Bluetooth devices

**Warning:** If Windows fails to find the Shimmer device, ensure the following;

- The PC attempting to find the Shimmer device is Bluetooth enabled.
- The Shimmer unit is powered ON (refer to *Section 2.2* to identify if Shimmer is powered ON).
- The Shimmer unit is within Bluetooth range of the PC (<12m approximately).

### Pair to a Shimmer device

To pair with a particular device, select the device from the list; the device name will be "RN42-XXXX" or "Shimmer3-XXXX", depending on what hardware version you have purchased, where "XXXX" are

the last four digits of the BT radio's MAC address (printed on the Shimmer label). Windows will attempt to establish a connection with the device.

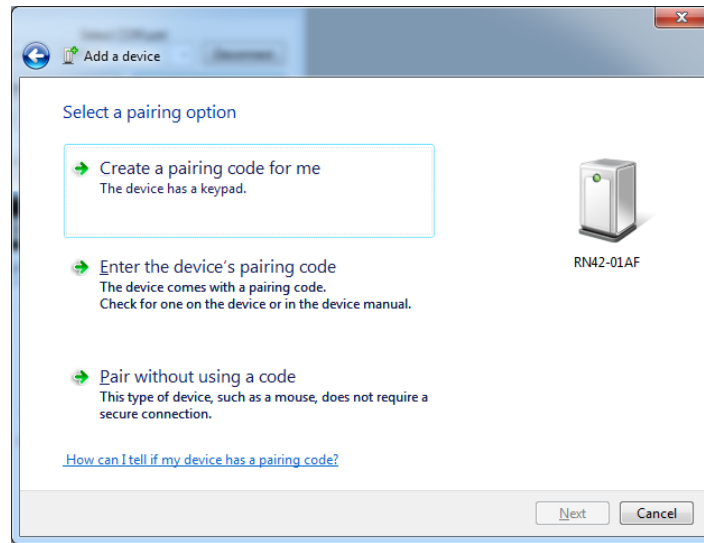

Figure 2-6 Pairing validation

To complete the pairing process, select the *Enter the device's pairing code* (see Figure 2-6) option at which point, a dialog box will appear prompting for a security code. The default code is **1234**.

### Verify successful Bluetooth pairing

Return to *Control Panel* → *Hardware and Sound* → *Devices and Printers* where the list of devices connected with the Windows machine should now include the Shimmer that you paired (see Figure 2-7). In order to use the device with many host side Shimmer applications, it is essential to know the COM port that the Windows machine has assigned to the Shimmer. To identify the COM port number, right click on the Shimmer, select *Properties* and go to the *Services* tab. The COM Port number is displayed as a Serial Port (SPP) service (e.g. COM74 in the screenshot on the right of Figure 2-7).

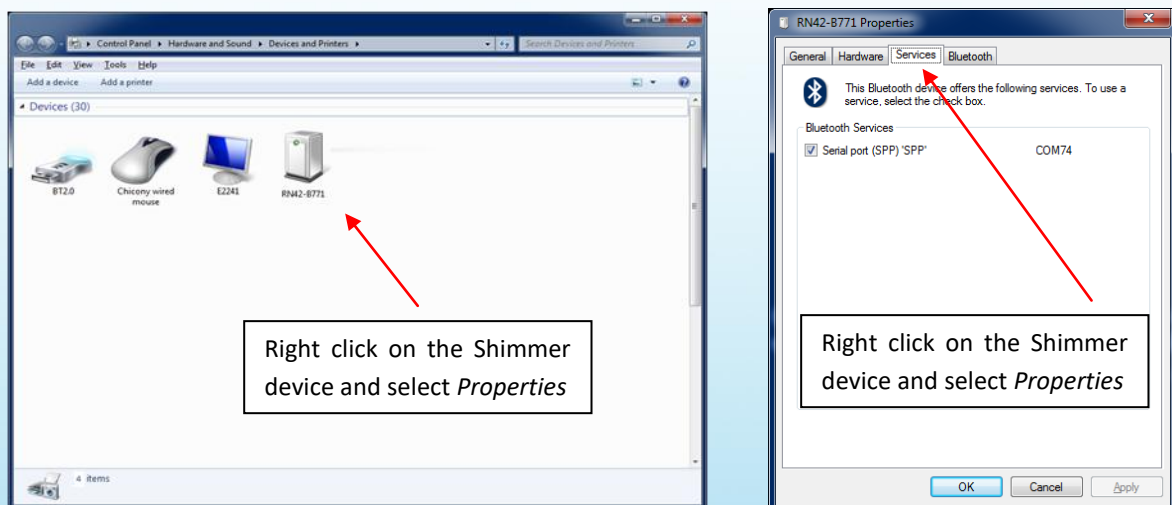

Figure 2-7 Locating COM port associated with the Shimmer unit

## 2.4.2. Bluetooth Pairing in Linux

The operation of pairing a Shimmer device in Linux may vary from distribution to distribution. The following procedure has been tested in Ubuntu 10.04, Slackware 13 and OpenSuse 11.3.

All the commands given here should be entered from the command line (in a terminal window).

### **Bluetooth Radio**

The BlueZ Bluetooth libraries and tools need to be installed. See <http://www.bluez.org> for details. Ensure the Bluetooth radio is available by running the **hciconfig** command.

```
tiny2@ShimmerLive:~/Desktop$ hciconfig
hci0: Type: USB
BD Address: 00:19:0E:0A:D6:62 ACL MTU: 1021:8 SCO MTU: 64:1
UP RUNNING PSCAN
RX bytes:1013 acl:0 sco:0 events:34 errors:0
TX bytes:1347 acl:0 sco:0 commands:34 errors:0
```

### **Search for Shimmer Devices**

Scan for the Shimmer by running the **hcitool scan** command.

```
tiny2@ShimmerLive:~/Desktop$ hcitool scan
Scanning ...
00:06:66:42:22:BD RN42-22BD
00:A0:96:28:DF:E8 FireFly-DFE8
00:06:66:42:24:18 RN42-2418
```

### **Pair to a Shimmer device**

To use the Shimmer, for example, with Bluetooth radio ID “RN42-2418”, it must be bound to an rfcomm device. The **rfcomm bind <n> <MAC\_ADDRESS>** command achieves this. The **<n>** parameter gives the rfcomm device number, which must be different for each Shimmer paired, and the **<MAC\_ADDRESS>** parameter is the Shimmers MAC address which can be obtained from the hcitool scan output above. This command normally needs root privileges, so “sudo” is used.

```
tiny2@ShimmerLive:~/Desktop$ sudo rfcomm bind 0 00:06:66:42:24:18
[sudo] password for tiny2:
```

### **Verify a Successful Bluetooth Pairing**

Running the **rfcomm** command with no arguments shows which Shimmer is bound to which rfcomm device, along with the current connection status.

```
tiny2@ShimmerLive:~/Desktop$ rfcomm
rfcomm0: 00:06:66:42:24:18 channel 1 clean
rfcomm1: 00:A0:96:28:DF:E8 channel 1 clean
```

## 2.5. Setting up a Shimmer data stream

### 2.5.1. Setting up a Shimmer data stream on Linux

*ShimmerCapture* is a host side application used to configure a single Shimmer and stream data from it. The application is available for the Linux operating system and is available from the Shimmer User Resources or for download from the members section of the Shimmer website. Follow the steps below on setting up a stream in *ShimmerCapture*.



## Run ShimmerCapture

Launch the *ShimmerCapture* application on a Linux OS.

**Linux:** The application must be run using the mono framework. The method of doing this varies and depends on the Linux distribution and the desktop environment being used. To run from the command line navigate to the folder containing the executable and run the **mono ShimmerCapture\_Linux.exe** command.

```
tiny2@ShimmerLive:~/Desktop$ mono ShimmerCapture_v0.2_Linux.exe
```

## Select a Shimmer

If you are running *ShimmerCapture* on a Linux OS, enter **/dev/rfcomm<n>** in the Select COM port field as in Figure 2-8. Only **/dev/rfcomm0** will be populated in the drop down menu, other values will need to be typed in manually.

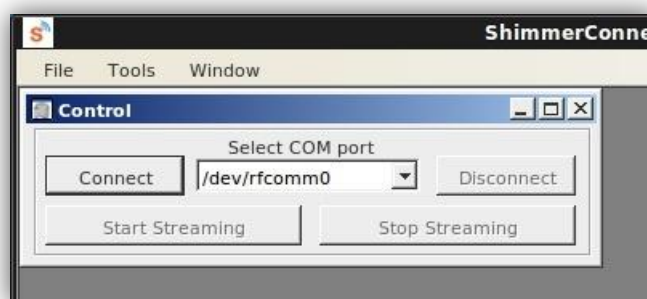

Figure 2-8 Selecting COM port in ShimmerCapture for Linux OS

## Connect to a Shimmer

Ensure the Shimmer unit is powered on and press the *Connect* button on the *ShimmerCapture* application to establish a Bluetooth connection between the Shimmer and the host side machine. As per Figure 2-3, the blue LED on the Shimmer will remain on when a successful connection has been made.

**Note:** If you have trouble connecting to a Shimmer please refer to the troubleshoot section of this manual.

## Configure the Shimmer

To configure the Shimmer, select *Tools* → *Configure Shimmer*. Here, Shimmer daughter boards can be enabled/disabled and sensor settings like the sampling rate can be defined. In Figure 2-9 the low noise accelerometer, wide range accelerometer and gyroscope sensors are enabled a sampling rate of 51.2Hz.

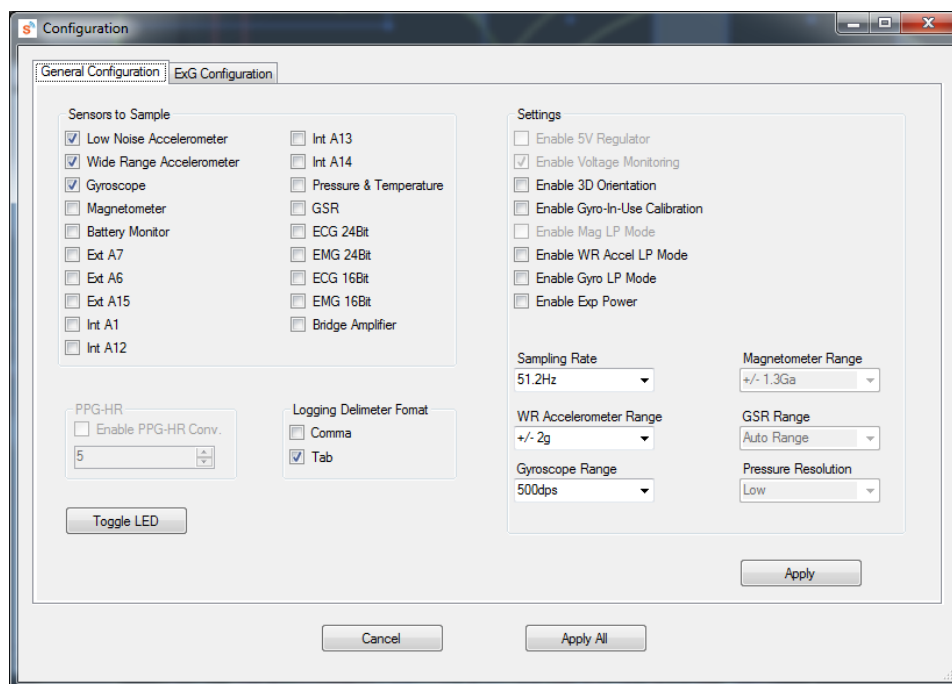

Figure 2-9 Configuring the Shimmer

### Stream data from the Shimmer

Press the *Start Streaming* button to start the Shimmer streaming data to the *ShimmerCapture* application. The blue LED on the Shimmer will blink with a 50% duty cycle at a rate of 0.5Hz (1s ON – 1s OFF). The data is displayed on the screen as in Figure 2-10.

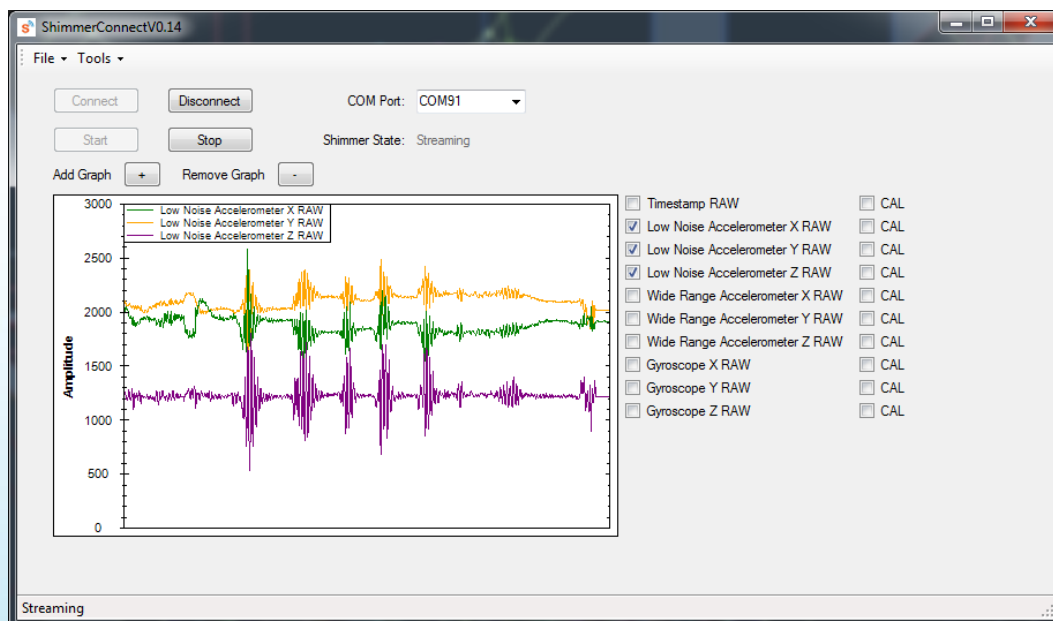

Figure 2-10 Shimmer streaming data

Data can be stored to a CSV file by pressing *Tools* → *Save to CSV*. To stop transmission, press the *Stop Streaming* button. If you press the *Disconnect* button, it will release the connection to the host application and remain idle.



For more information on the functionality of *ShimmerCapture* please refer to the *Section 4.1.2* of this manual. For more information on the use of *LogAndStream* firmware please refer to the *Section 5.1.1* of this manual.

## 2.5.2. Setting up a Shimmer data stream on Windows

*ConsensysPRO* is a host side application used to configure one or more Shimmers and stream data from it. The application is available for Windows from the Shimmer User Resources or for download from the Shimmer website. Follow the steps below for setting up a stream in *ConsensysPRO*.

### ***Navigate to the live data tab***

When *ConsensysPRO* is launched press the *Live Data* button or tab as indicated below in Figure 2-11.

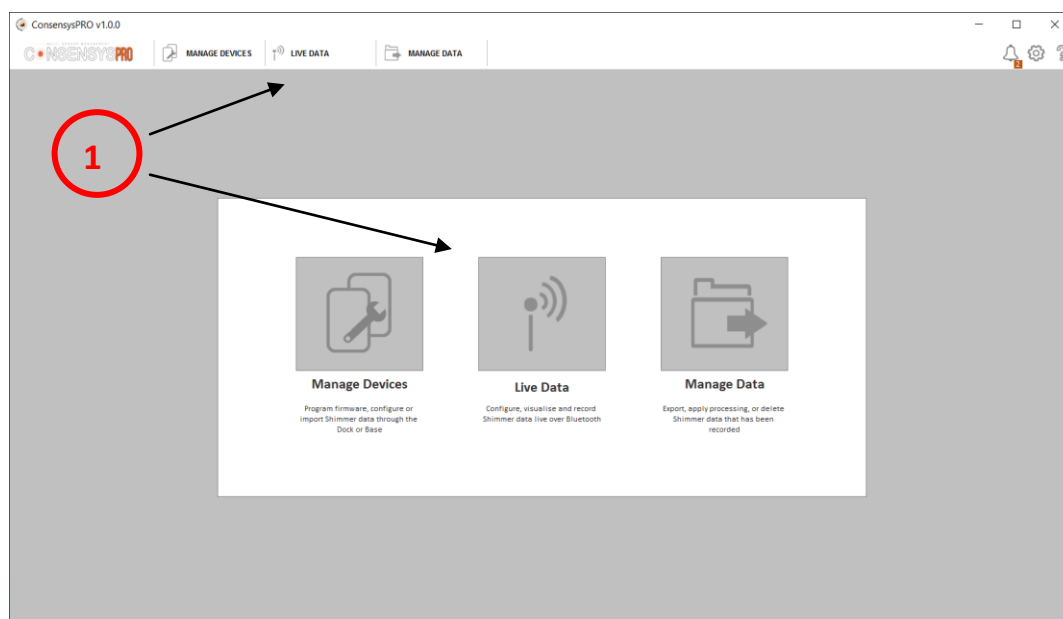

Figure 2-11 Navigating to setting up data stream in Consensys

### ***Connect to a Shimmer***

Ensure the Shimmer unit is powered on and running *LogAndStream* firmware (v0.8.0 or later), then press one of the *Connect* buttons highlighted in Figure 2-12. The blue LED on the Shimmer will turn continuously on when a successful connection has been made.

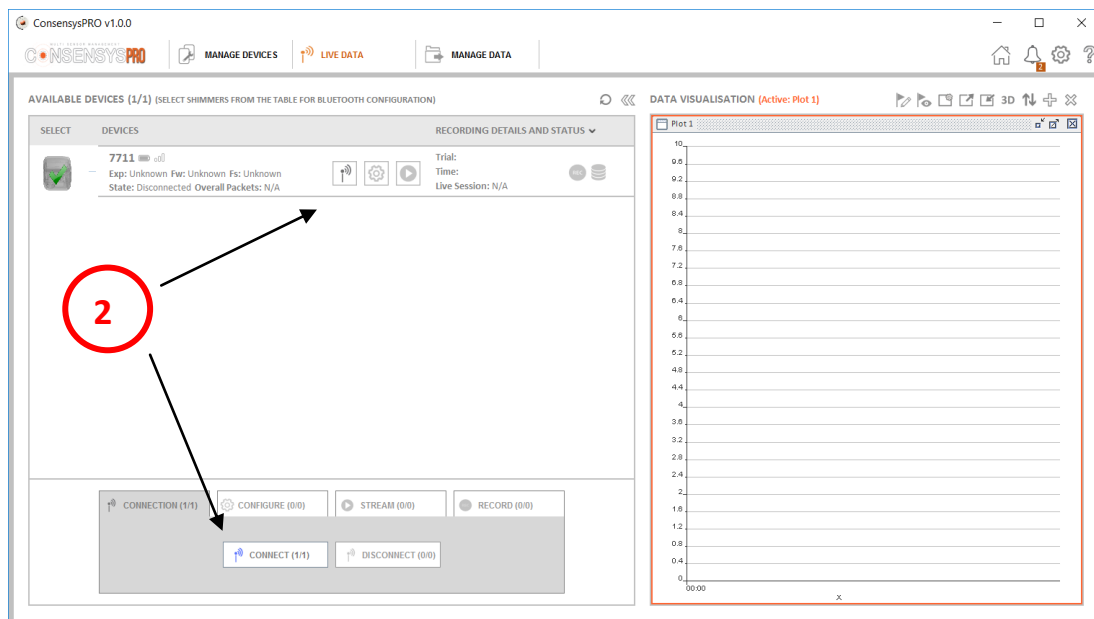

Figure 2-12 Connecting to the Shimmer

### Accessing the Shimmer configuration

To configure the Shimmer, select one of the *Configure* buttons as shown below in Figure 2-13.

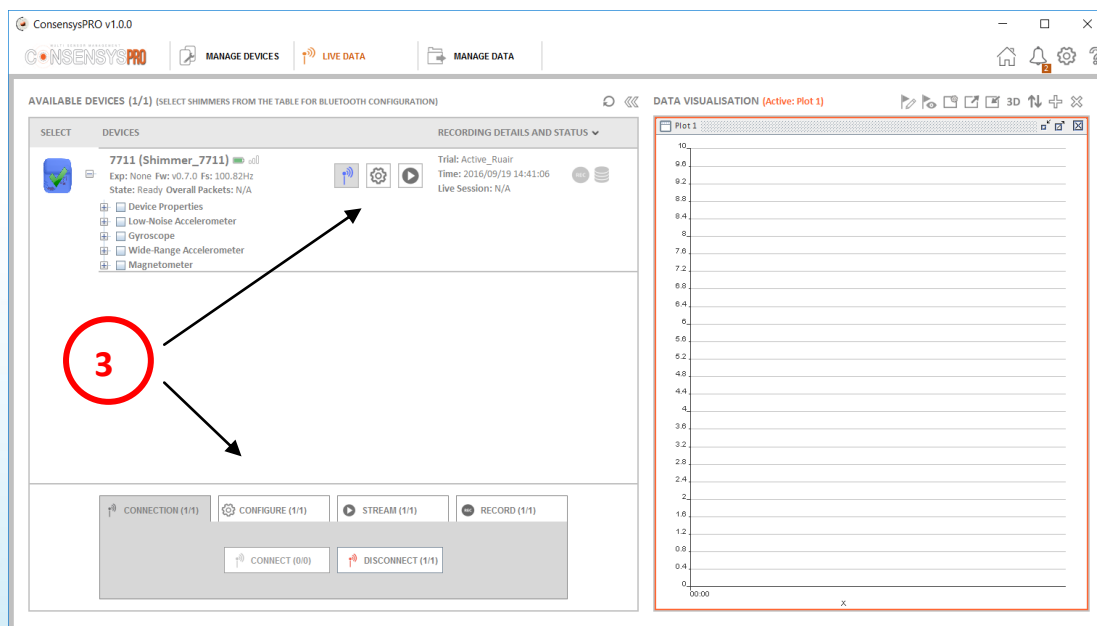

Figure 2-13 Accessing the Shimmer configuration

## Configuring a Shimmer

Here, Shimmer sensors can be enabled/disabled and sensor settings like the sampling rate can be defined. In Figure 2-14 the low noise accelerometer at a sampling rate of 51.2Hz is enabled. Press the *WRITE CONFIG* button to write the configuration over Bluetooth to the Shimmer.

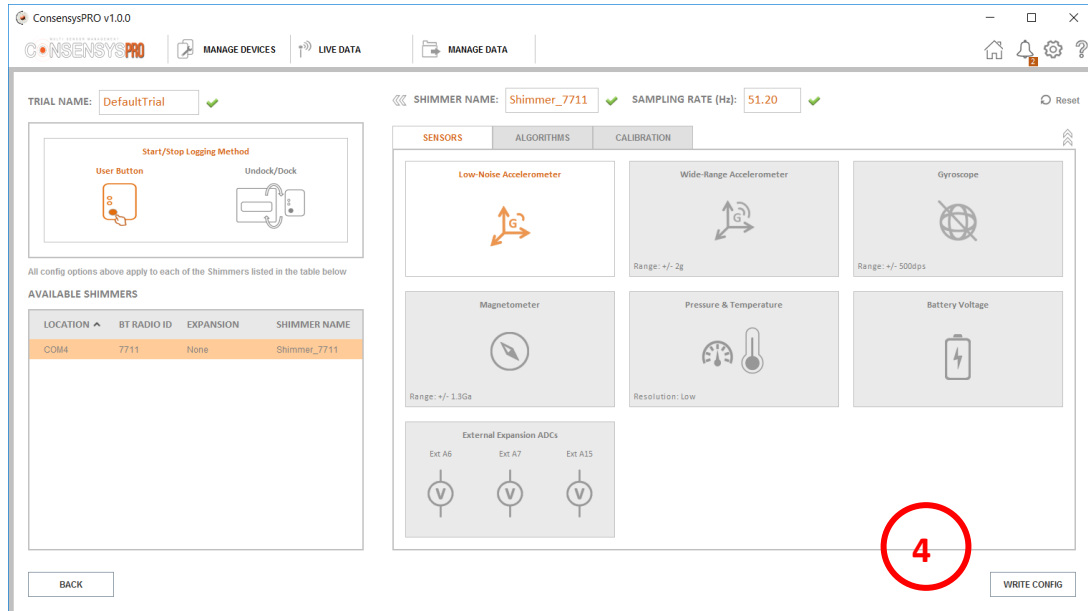

Figure 2-14 Writing the Shimmer configuration

## Stream data from the Shimmer

Press one of the *Start Streaming* buttons to start the Shimmer streaming data to the *Consensys* application. The blue LED on the Shimmer will blink with a 50% duty cycle at a rate of 0.5Hz (1s ON – 1s OFF). The data is displayed on the screen as in Figure 2-15.

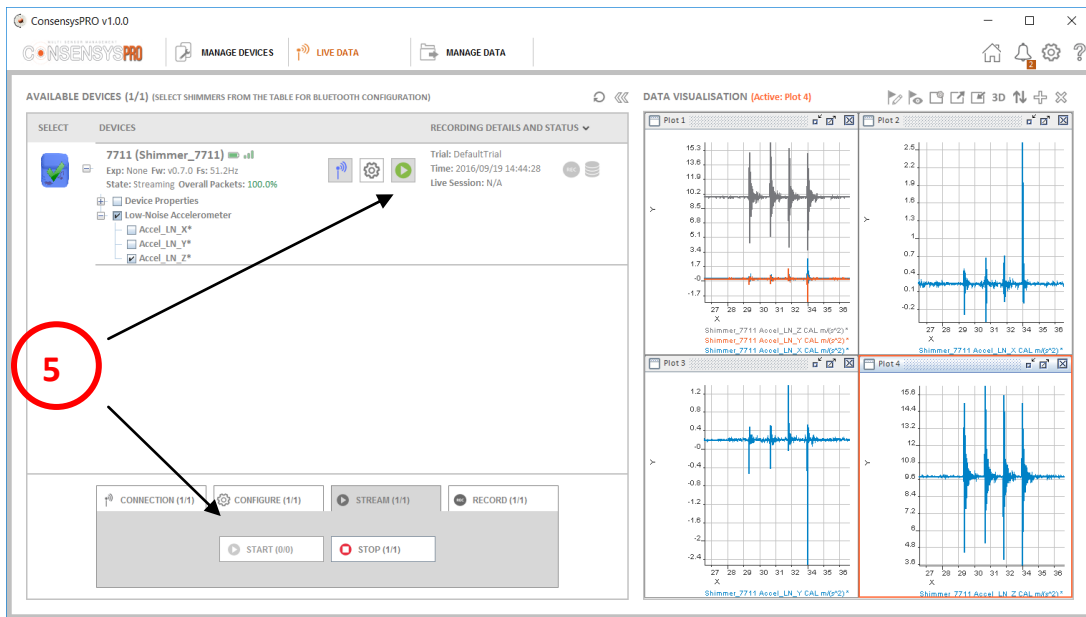

Figure 2-15 Shimmer streaming data

### Recording data from the Shimmer

Data can be stored to the PC (via a Consensys database) and/or locally to the Shimmer's SD card as shown in Figure 2-16. It can then be exported to a text file for data visualisation or data processing.

For more information on the functionality of *ConsensysPRO* please refer to the *Section 4.1* of this manual. For more information on the use of *LogAndStream* firmware please refer to the *Section 5.1.1* of this manual.

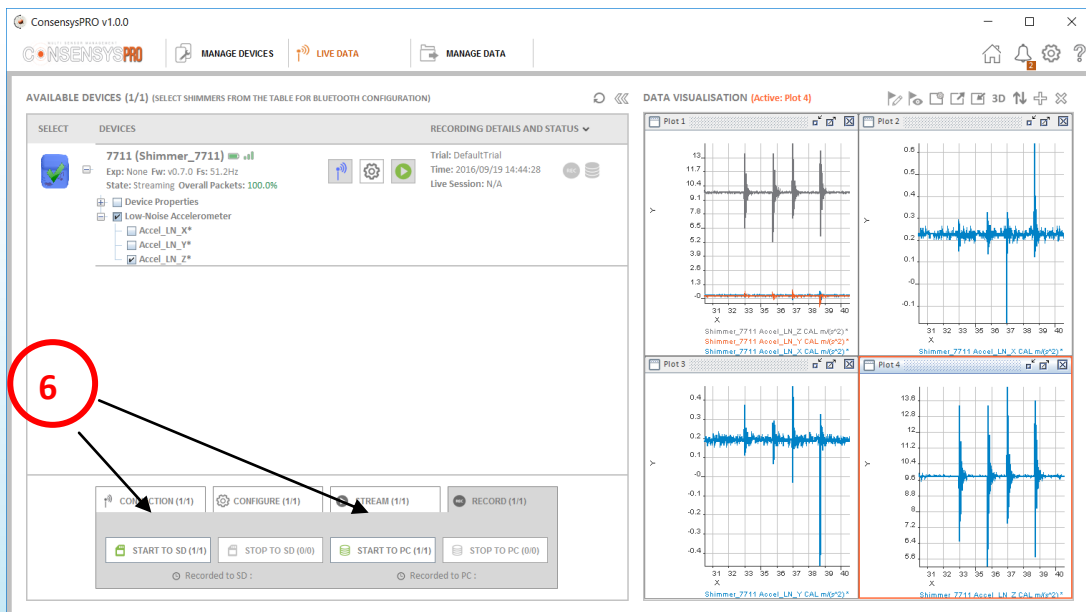

Figure 2-16 Shimmer recording data

### 3. Shimmer3 Platform Overview

This section provides an overview of the main components of the *Shimmer3 platform*. The scope and level of detail provided here is aimed at the general Shimmer user and should be sufficient for understanding the core concepts of the *Shimmer3 platform*. For more specific and detailed information, please refer to the later sections of this document along with the additional user guides, which are referred to throughout the document.

#### 3.1. Components

Table 3-1 lists the key components of the *Shimmer3 platform*.

Feature	Purpose	Component/Capabilities
I/O	Capture of sensor and user data.	<b>Integrated</b> <ul style="list-style-type: none"> <li>3 Axis Low Noise Accelerometer array</li> <li>3 Axis Wide Range Accelerometer array</li> <li>3 Axis Gyroscopes (Angular Rate sensors)</li> <li>3 Axis Magnetic Sensor</li> <li>Relative Pressure Sensor (Altimeter)</li> <li>Temperature Sensor</li> <li>5 multi-coloured status LEDs</li> <li>Software-defined user button</li> </ul> <b>Expansion</b> <ul style="list-style-type: none"> <li>7 channels of analog expansion</li> <li>UART, SPI, and I2C peripheral bus support</li> <li>18-position rugged external connector (Hirose ST60 series) for charging, programming, flash data access, additional analog channels and tethered sensor extensions.</li> <li>Keyed 16-signal micro-sized stacking connector for serial or analog peripherals</li> <li>FFC-Type expansion header for alternative radio chipset, coprocessor, or digital peripherals</li> <li>JTAG debugging mode on external connector</li> </ul>
Processing	Control operating state.  Provide best signal quality.  Operational alerts and messages.	<b>MSP430F5437A CPU</b> <ul style="list-style-type: none"> <li>16Kbyte RAM, 256Kbyte Flash</li> <li>Up to 24MHz</li> <li>DAC outputs</li> <li>12 bit A/D inputs</li> <li>Extremely low power during periods of inactivity</li> <li>Hi-tolerance clocking including .5ppm temperature compensated crystal oscillator module.</li> </ul>
Storage	No loss of data while mobile, during network outages or while changing batteries.	<b>microSD slot</b> <ul style="list-style-type: none"> <li>Up to 32GByte capacity</li> <li>Full-speed host transfer when docked (requires use of Shimmer Dock).</li> <li>Soft-power control</li> </ul>
Communication	Hi-reliability. Standards-Based . Mobility.	<b>Class 2 Bluetooth Radio</b> <ul style="list-style-type: none"> <li>Roving Networks RN-42</li> <li>Soft-power control</li> </ul>
Power	Long operating life.  Safe operation.	<ul style="list-style-type: none"> <li>Battery voltage monitoring</li> <li>450mAh Battery</li> <li>Smart charger</li> <li>Designed for EN 60601-1 Compliance</li> </ul>

Table 3-1 Shimmer3 Mainboard Key Features

Figure 3-1 shows the individual components of the Shimmer3. To open the case, loosen the two screws with a T-6 Torx screwdriver and open the case carefully by pulling up on the screw side and carefully disengaging the tabs on the opposite side of the unit. Note the position of the PCB, wires, button, slide-switch actuator (if present), and battery for re-assembly. For more detailed instructions on assembly and disassembly, refer to *Appendix C – Opening or assembling the Shimmer3 enclosure*.

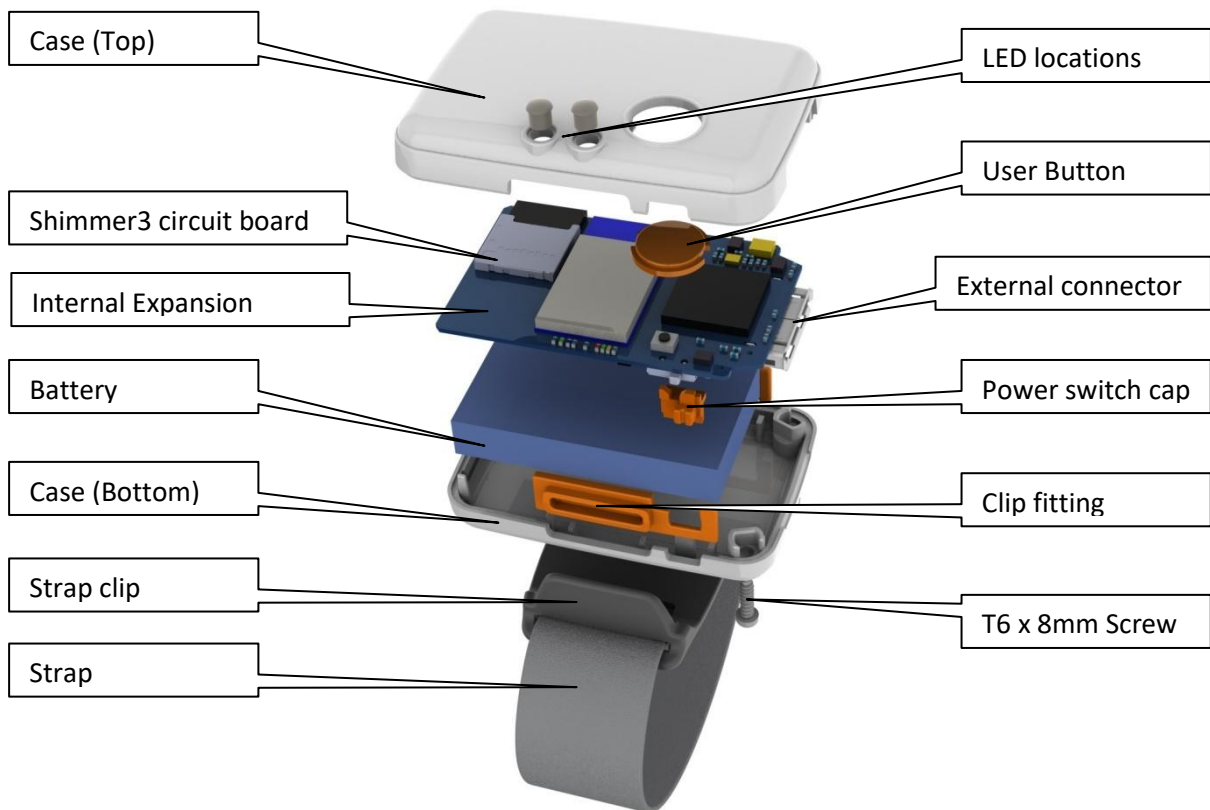

Figure 3-1 Shimmer3 Exploded view

### 3.1.1. Power switch

Shimmer units arrive from the factory programmed with *LogAndStream* firmware with power switched off. To power-on, use the slide switch (highlighted in Figure 3-1).

The power-off feature on the Shimmer unit is intended for storage or transportation. If you wish to leave a Shimmer in a low-power state without turning off the device, you should program the Shimmer with the Sleep firmware (see *Section 5.1.3*).

### 3.1.2. Battery

Like many personal electronic devices, Shimmer is powered by a rechargeable Lithium Polymer battery. The Shimmer battery is 3.7V, 450 mAh and contains a safety circuit board with over-current protection, which can trigger if a component short is created by a faulty peripheral or if components are bridged while the enclosure is open. The battery will return to normal operating condition after the short is removed and the unit is placed back in a Dock.

The Shimmer operating life when using these batteries depends on a number of factors including which, if any, radio is in use, which sensors are enabled and the rate at which data is being sampled

and transferred. Battery life estimation information for a number of different configurations is provided in *section 6.2.3* and also contains further details on voltage measurement.

Some Shimmer applications feature a low-battery message using an LED indicator (located near the reset button). There is also hardware low-battery protection which will prevent damage to the battery or Shimmer device. If your application fails to start or terminates abruptly after initiating streaming data over a radio or writing to flash, it could be a symptom of a battery in need of recharging. For details on battery re-charging please refer to *Section 3.2.3* of this User Manual. If you suspect a fault with your Shimmer battery, please refer to the troubleshooting section of this manual.

### **3.1.3. User button**

There is an orange-coloured user button on the Shimmer3 (highlighted in Figure 3-1), whose function is defined by firmware. Users should note that this button does not provide tactile feedback. All firmware solutions provided by Shimmer include visual feedback when the user button is pressed and it is recommended that any users who wish to develop firmware do the same.

### **3.1.4. Shimmer LED Indicators**

Two software-controlled LED indicators (highlighted in Figure 3-1) are available, the lower indicator is intended to display operational status and is tri-coloured (green, yellow, and red). The upper indicator is bi-coloured (blue/green) and is intended to display the data communication mode or status.

Firmware developers are encouraged to follow international standards for indicator lights, for example:

- Operational status:
  - Green: Correct operation
  - Yellow: Warning
  - Red: Error
- Data status
  - Blue: Bluetooth
  - Green: Sensing

### **3.1.5. MicroSD Card Socket**

The Shimmer mainboard contains a microSD card socket to incorporate extra memory resources, with capacities up to 32GB. This allows the additional storage of data while the Shimmer is not streaming and ensures no loss of this data while mobile, during network outages or while changing batteries.

You will find the microSD card socket on the corner of the PCB with a label printed on the PCB in the socket opening. As Shimmer has a power switch on this component, there is no drawback to leaving a card installed at all times. The card socket is spring-loaded and you can insert the card from the side without complete disassembly.

The microSD card may be accessed using the *Shimmer Dock or Consensus Base*. For more information on microSD card access please refer to *Section 3.2.4* of this document.



For further hardware-based information on the microSD card socket, please refer to *Section 6.2.2* of this manual. For information on firmware solutions for using the microSD card please refer to *Section 5.1* of this manual.

**Note:** The Shimmer is not compatible with SDHC cards.

### 3.1.6. Internal Connector

The expansion connector is on the top side of the Shimmer and consists of both J6 and J7, as shown in Figure 3-2. It is used to connect to internal daughter boards. All expansions will include appropriate enclosures.

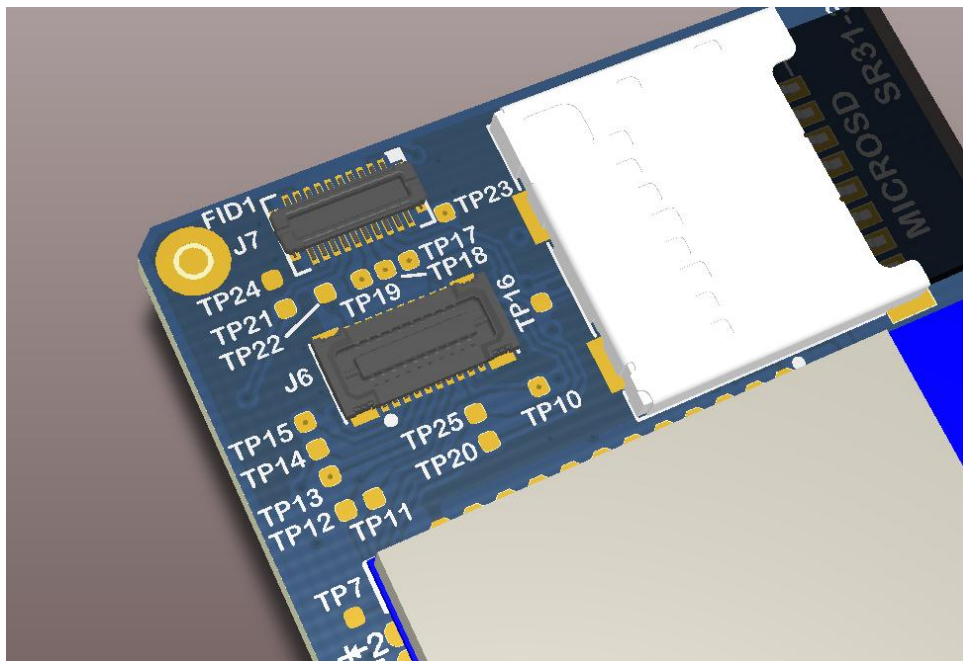

Figure 3-2 Shimmer3 mainboard's internal expansion connector

Care should be taken when making decisions about hardware configuration, in order to minimise the number of times that boards are removed from and inserted into the internal connector. The connector is rated for up to four insertions.<sup>2</sup>

Never force the expansion board when connecting it to the *Shimmer mainboard* and be sure to install it with the board aligned with dimensions of the Shimmer PCB. The connection is keyed and its orientation is visually obvious. The expansion enclosure may be self-aligning to assist in the assembly process.

For further hardware-based information on the internal connector please refer to *Appendix A - Mainboard detail for Debug and Testing*.

---

<sup>2</sup> Since September 2014, all expansion modules sold by Shimmer are permanently fixed to the *Shimmer3 mainboard*. Removal of the expansion board from the mainboard should not be carried out under any circumstances. Doing so will cause damage to one or both of the boards and any necessary repairs will not be covered by warranty.



### 3.1.7. External Connector

The *Shimmer mainboard* connects to the *Shimmer Dock* and *Shimmer Multi Charger* via the External Connector (highlighted in Figure 2-1). The External Connector can also be used to attach external expansion boards. The External Connector is keyed and does not require force to attach to a device.

For further hardware based information on the External connector please refer to *Appendix A - Mainboard detail for Debug and Testing*.

## 3.2. Shimmer Dock

The *Shimmer Dock* (referred to as the Dock in this section) is a multi-purpose device which can provide three primary functions, as described in more detail throughout this section:

- Charging the Shimmer
- MicroSD Card access
- Programming the Shimmer

Whilst there have been several Dock design iterations, the current dock is the *Shimmer Programming Dock v3*, which is best identified by a square white enclosure, with a power/reset<sup>3</sup> button containing an LED for power indication, a black user button and an LED indicator (see Figure 3-3).

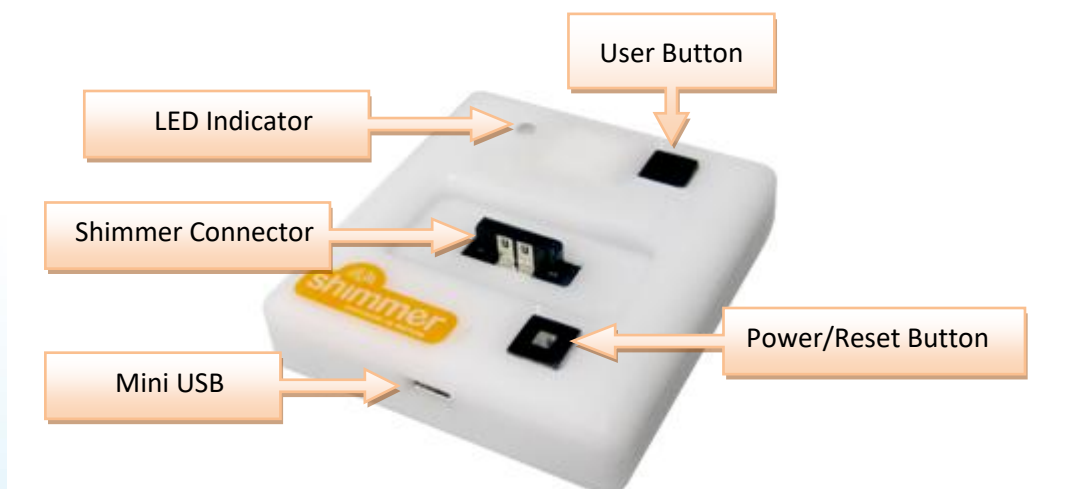

Figure 3-3 Shimmer Dock – enclosure view

The different features of the Dock are summarised in Table 3-2.

<sup>3</sup> To power on/off a Shimmer3 device, the slide switch on the device must be used.

Item	Status / Function
<b>Power/Reset Button<sup>1</sup></b>	Reset (quick press).
<b>Power/Reset Button Indicator</b>	<b>Solid Green</b> when Shimmer is powered on
<b>User Button</b>	Application specific signal to Shimmer
<b>Charge Indicator</b>	<b>Solid Yellow</b> during primary charging state
<b>microSD Indicator</b>	<b>Blinks Blue</b> with host PC access to Shimmer microSD
<b>UART Indicator</b>	<b>Blinks Orange</b> during programming (BSL) or UART activity

Table 3-2 Shimmer Dock features

The Dock connects to a PC via a USB cable. Whilst drivers for the microSD Card Access should already exist on your PC, you may need to manually install USB Serial Converter drivers to use the Dock for programming the Shimmer. You should perform the installation of these drivers before you first connect your Dock to the PC. Later versions of Windows (e.g., Windows 10) normally have this driver pre-installed and so manual installation might be necessary.

**Warning:** If you are using an older version of Windows (typically less than Windows 10) and you connect the Dock to a PC, do not allow Windows to install the driver automatically.

**Note:** For more information about the Dock, including troubleshooting, please refer to the *Shimmer Dock User Guide*, which can be obtained from the folder `\Documentation\Hardware User Guides` in the *Shimmer User Resources* distribution.

### 3.2.1. USB Serial Converter Driver Installation

1. The USB Serial Converter drivers for the Dock can be downloaded from the [FTDI Chip Drivers webpage](#). Download and install the driver to match your operating system.
2. Plug in your Shimmer USB Dock or USB reader. If the reader hasn't been powered recently, you may get a driver error. Simply unplug and try again.
3. Verify your system settings:
  - I. From the *Control Panel*, select *Device Manager* (in Windows this is found from *Control Panel* → *System* → *Hardware* → *Device Manager* or by typing `devmgmt.msc` in the Start menu) and expand the *USB* or *Universal Serial Bus controllers* entry as shown in *Figure 3-4*.
  - II. You should see at least two entries for *USB Serial Converter* (the other entries will vary with system configuration and may not match the image above exactly).

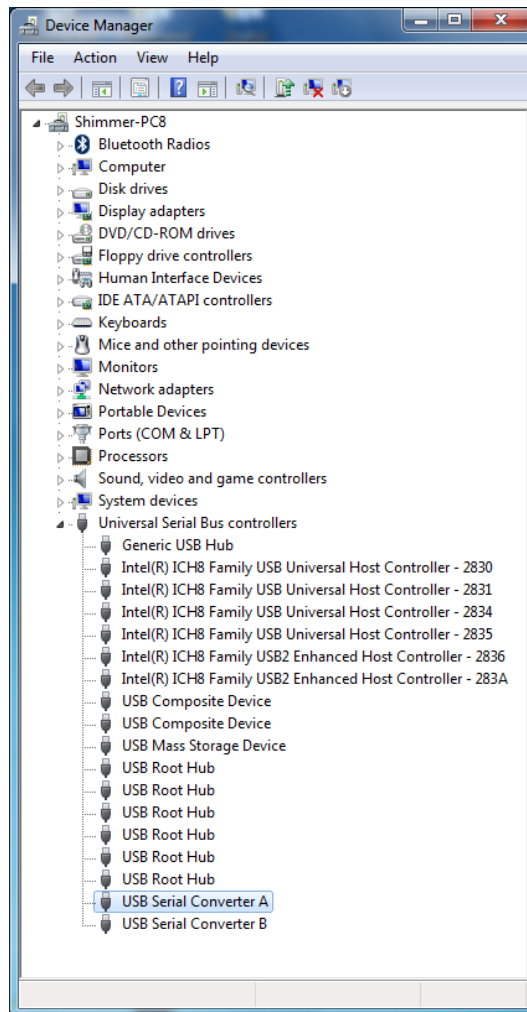

Figure 3-4 Device Manager showing USB Serial Converter A and B

- III. Double-click on **each** *USB Serial Converter* entry and under the *General* tab, confirm that the manufacturer is FTDI. Then, under the *Advanced* tab, make sure the *Load VCP* checkbox is ticked (see Figure 3-5). If the checkbox isn't ticked, you will need to tick for each Serial converter and then unplug and re-insert the dock.

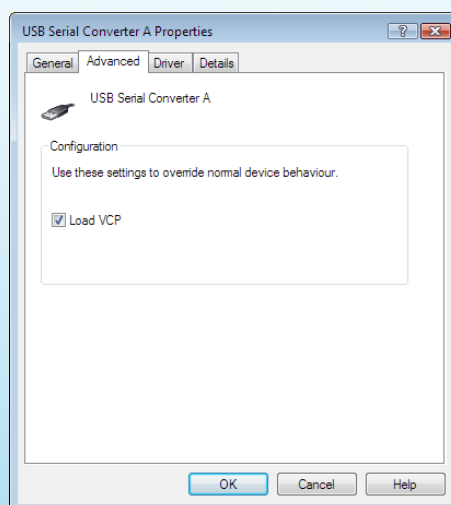

Figure 3-5 USB Serial Converter Properties

- IV. Next, under the *Ports (COM & LPT)* entry in the *Device Manager*, you should see two new *USB Serial Port* entries, each with an associated COM port number, as shown in Figure 3-6. The *USB Serial Port* with the lowest number is the *Programming Port*.

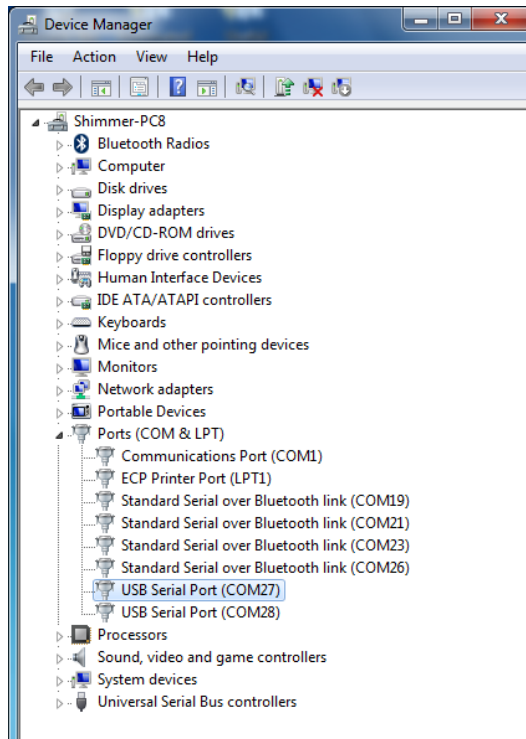

Figure 3-6 Device Manager showing Dock USB Serial Ports

- V. Double-click on **each** of these *USB Serial Port* entries and, under the *Port Settings* tab, click on *Advanced...* In the *Miscellaneous Options* at the bottom right-hand side of the window, ensure that *Set RTS On Close* is ticked, as shown in Figure 3-7.

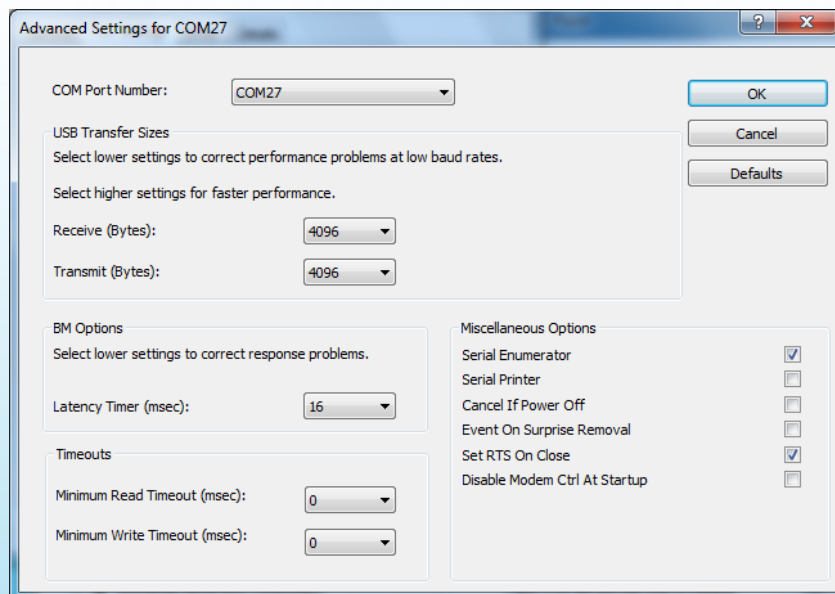

Figure 3-7 Advanced Port Settings: Select Set RTS On Close

The first of the USB Serial Port entries should be the outgoing COM Port associated with your dock; this will be used for programming Shimmer devices and should be noted for future use.

### 3.2.2. Placing a Shimmer in the Dock

The Dock connects to the Shimmer via the External Connector. The External Connector is keyed and does not require force to insert. Insert the Shimmer with the Bluetooth ID label facing away from the USB cable.

**Warning:** Forcing the connector may cause permanent damage to your Shimmer.

When the Shimmer is placed in the dock, the green LED on the Power/Reset button on the dock will light up green if the Shimmer is powered on. If it does not light up, one of the following may have occurred:

- Shimmer unit may be powered off -- check the slide power switch.
- Shimmer unit may not be inserted properly.
- Dock may not be powered via the USB cable.

### 3.2.3. Charging the Shimmer

The Dock, Base and *Multi Charger* are multi-functional devices – all of which are capable of charging Shimmer units. This section outlines the use of the Dock for charging a Shimmer unit. For details on using the *Multi Charger* please refer to the *Shimmer Multi Charger User Guide*.

In order to use the Dock as a charging device simply connect the USB cable of the Dock to a powered USB socket and insert the Shimmer unit into the Dock.

**Note:** You should make sure your Dock is powered when a Shimmer is docked as the Shimmer battery will discharge if it is left idle in a Dock that is not powered.

The state of the charge indicator LED is an indication of charge phase for the battery. There are three phases to Shimmer battery charging, illustrated in Figure 3-8. The background colour on the graph in Figure 3-8 indicates the colour of the charge indicator LED on the Dock during each phase.

Phase 1 is a *Preconditioning Phase* and is only required when the battery voltage has dropped below a minimum threshold. The battery voltage should not drop below this minimum threshold with normal everyday use. However, if a Shimmer is left idle for a long period of time, the battery may self-discharge to a voltage below the minimum threshold. During the *Preconditioning Phase*, a low current (12.5mA) is applied to bring the voltage to the *Minimum Charge Voltage*. The duration of pre-conditioning will depend on the extent to which battery is discharged. For example, a Shimmer that has been unused for several months and was discharged before storage may have a lengthy pre-conditioning phase.

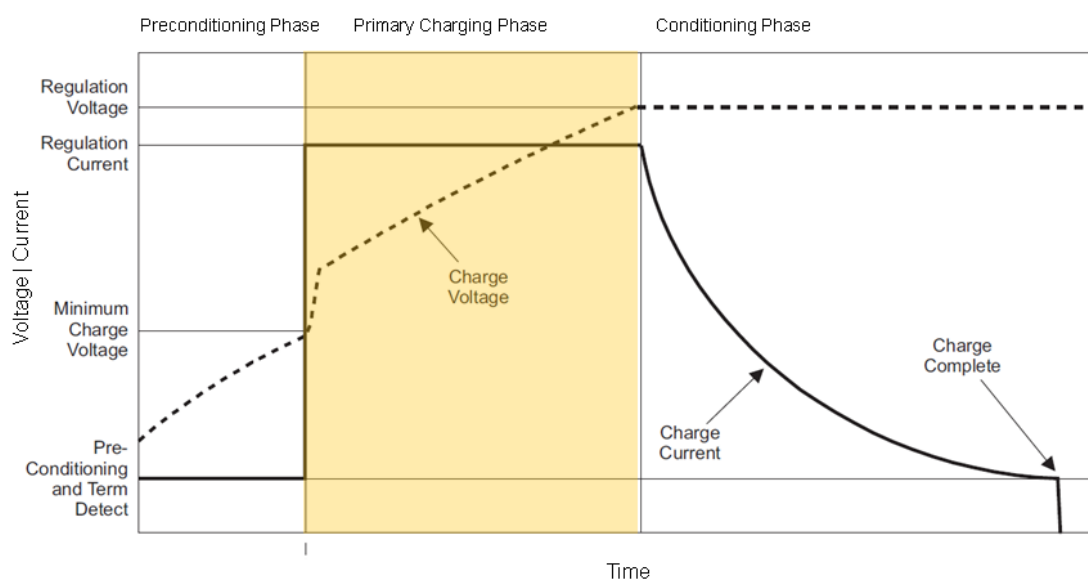

Figure 3-8 Shimmer Battery Charging Phases. The background colour on the graph indicates the colour of the charge indicator LED on the Dock during this phase.

For the most efficient recharging after a deep discharge, it is recommended to program the Shimmer unit with the *Sleep* firmware image (see *Troubleshoot* section for further details). During the *Preconditioning Phase* the charge indicator LED on the Dock will be off.

Phase 2 is the *Primary Charging Phase*. This phase is the standard charging phase and involves the application of a constant current (125mA) to bring the battery voltage to the *Regulation Voltage* level. During this phase, the charge indicator LED on the Dock will illuminate yellow/orange.

Phase 3 is the *Conditioning Phase*. The charger will continue to condition the battery as long as the Shimmer remains inserted in the charger. For maximum operating life, it is advisable to allow as much conditioning time as your needs allow. During this phase, the charge indicator LED on the Dock will be off.

The duration of primary charging for a standard Shimmer battery (3.7V - 450mAh) is typically 4.5 hours. Knowing that the Shimmer charges at 125mA/hr and conditions at 12.5mA/hr, it is possible to estimate charge times for larger or smaller batteries. The charger has a 6.16hr time-out. Users using >800mAh capacity rechargeable batteries need to increase the charge rate on the *Shimmer mainboard* to ensure a full charge; please contact [support@shimmersensing.com](mailto:support@shimmersensing.com) for further details.

### 3.2.4. microSD Card Access

When a Shimmer with microSD card is inserted into a Dock that is connected to a PC, the standard drivers on the host system should mount the microSD card as though it were a USB flash key. Depending on the specifics of your system, a few things may happen:

- A window may open to display the contents of the SD card.
- A prompt window may pop-up and ask you what you want to do.
- Nothing may happen, but when you click on the drive letter or volume name associated with the USB port of the USB Dock, the contents of the SD card may be browsed.

If you experience difficulties accessing the microSD card, please consult the *Shimmer Dock User Guide* which can be obtained from the folder `\Documentation\Hardware User Guides` in the *Shimmer User Resources* distribution.

### 3.2.5. Programming a Shimmer

When a Shimmer is inserted in the Dock it can be programmed with pre-compiled firmware images using a Bootstrap Loader application. For further information on programming Shimmers please refer to section 5.2 of this document.

## 3.3. Consensys Base

*Consensys Base* hardware (referred to as the Base in this section) is a multi sensor management system with an integrated software solution (see Consensys in section 4.1 for further information), for the simple and effective management of all your Shimmer data. The Base allows users to easily configure and capture data from up to 15 Shimmers simultaneously and provides ability to:

- Charge Shimmers
- Data download through MicroSD Card access
- Program Shimmers
- Configure Shimmers



Figure 3-9 Consensys Base (Base6U and Base15U from L-R)

### 3.3.1. Consensys power-up order

1. Undock all Shimmers from the Base.
2. Plug in the mains power supply and connect to the Base.
3. Connect the USB cable from a computer to the Base.
4. Wait for all drivers to install.
5. Dock Shimmers.



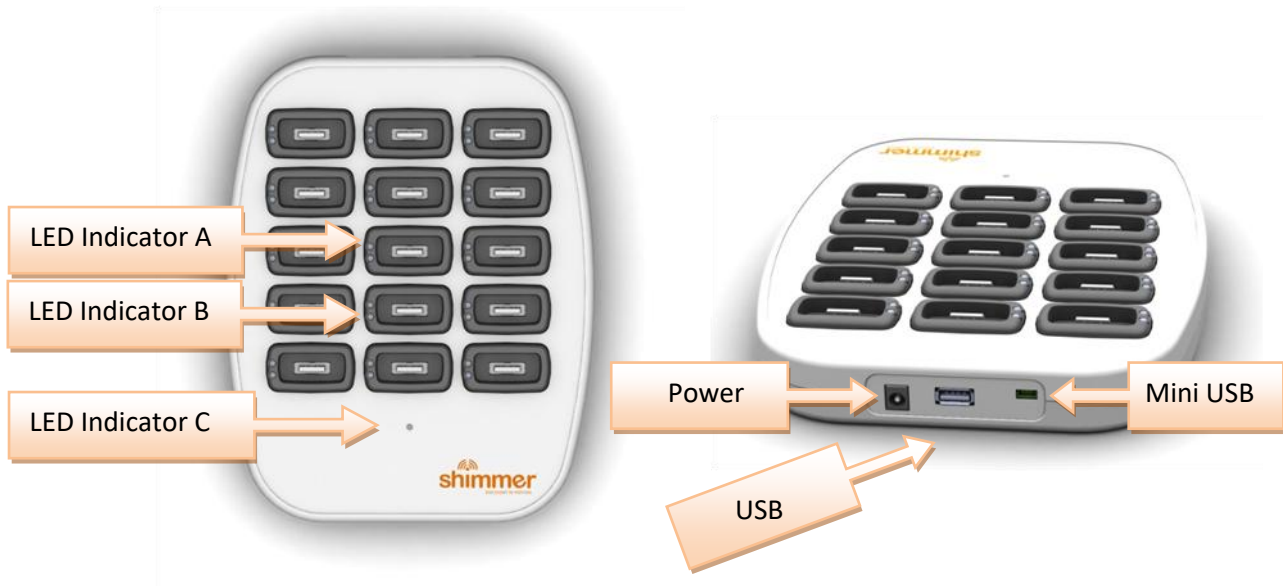

Figure 3-10 Consensys Base – enclosure view

Item	Status / Function
<b>LED Indicator A</b>	<b>Solid Green</b> if a Shimmer is docked
<b>LED Indicator B</b>	Active slot indicator; <b>Solid Blue</b> if SD access, <b>Solid Orange</b> if UART access
<b>LED Indicator C</b>	<b>Blinks Orange</b> if Base is powered and Consensys software is running
<b>Power</b>	12V, 5A power supply
<b>USB</b>	USB hub for chained Consensys Bases
<b>Mini USB</b>	For UART communications with the Shimmers in the Base

Table 3-3 Consensys Base features

### 3.4. Other Accessories and Shimmer Platform Components

#### 3.4.1. Shimmer3 Variations

Shimmer provides sensing units other than the standard Shimmer3 kinematics module including the Shimmer3 ECG, Shimmer3 EMG, Shimmer3 GSR+, Shimmer3 Bridge Amplifier+ and the Shimmer3 PROTO3 Series. Each sensing unit has a corresponding user guide which details the specifications of the board, as well as providing information on appropriate use of the board. A copy of each user guide can be obtained from the folder `\Documentation\Hardware User Guides` in the *Shimmer User Resources* distribution or by downloading it from the [Shimmer website](http://www.ShimmerSensing.com).



Currently available Shimmer sensing units are the:

- ECG: digital front-end optimized for measuring physiological signals like ECG.
- EMG: digital front-end optimized for measuring physiological signals like EMG.
- GSR+: analog front-end for the measurement of skin conductance, along with a 3.5mm jack for analog or digital input from an external sensor such as the [Optical Pulse Sensing Probe](#) from Shimmer.
- Bridge Amplifier+: a bridge amplifier, excitation source, and connector enabling force measurement with Shimmer, along with connector and amplifier for resistance measurement.
- *PROTO3 Series*: a series of prototyping boards for connecting external sensors to the *Shimmer3*.

Please refer to the Shimmer website for more information about new releases.

### 3.4.2. Multi Charger

The primary function of the Multi Charger (see Figure 3-11) is to allow for the simultaneous charging of up to six Shimmers. The Multi Charger also has a Reset Button which allows for synchronised reset of multiple Shimmers.



Figure 3-11 Shimmer Multi Charger

For further information, please consult the *Shimmer Multi Charger User Guide* available in the folder, `\Documentation\Hardware User Guides`, in the *Shimmer User Resources* distribution or available for download from the [Shimmer website](#).

### 3.4.3. Shimmer3 JTAG Adapter Board

The Shimmer3 JTAG Adapter Board, shown in Figure 3-12, can be used by firmware developers for debug and programming purposes. It can also be used to provide input signals from analog sensors or for peripheral prototyping. It installs in-line with *Shimmer Dock* to enable use of 3rd party JTAG programming and debugging tools. The *Shimmer3* connector, labelled in the figure, should be inserted into the *Shimmer3* external connector and the Dock connector should be connected directly to the *Shimmer Dock*. Alternatively, the board can be powered directly via the USB power-only connector, for use without a *Shimmer Dock*.

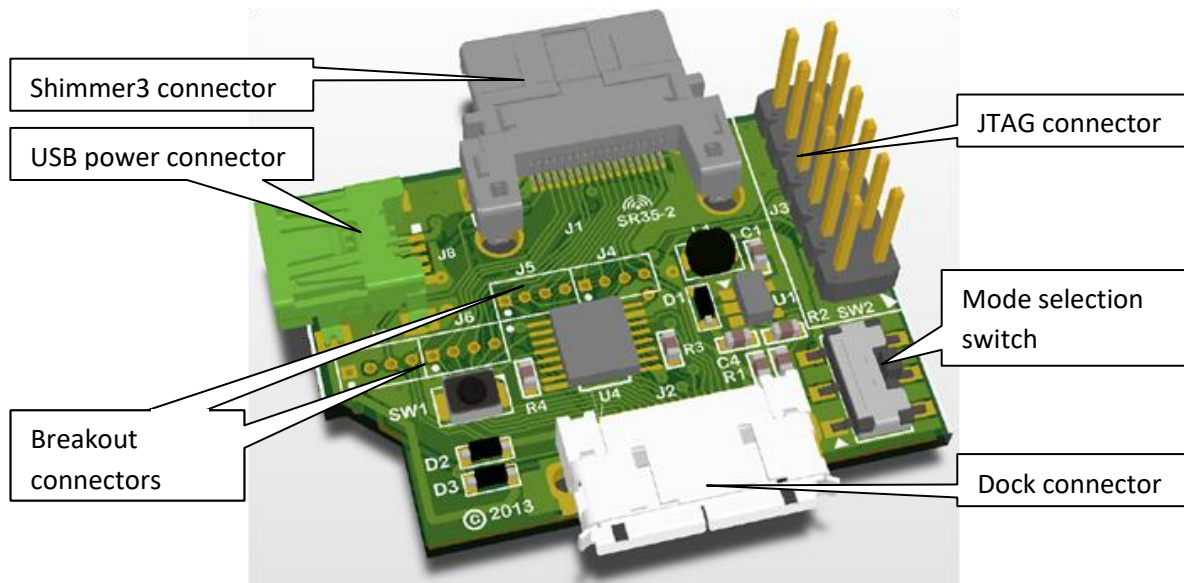

Figure 3-12 Shimmer3 Programming Adapter

When the mode-selection slide switch is down, JTAG is disabled (normal dock operation). When the switch is up, only power is provided by the dock and various signals are reconfigured to provide a JTAG port. For more information and pin-out details, please refer to the *Shimmer3 JTAG Developer Board User Guide*.

#### 3.4.4. Shimmer3 Calibration Stand

The *Shimmer3 Calibration Stand* should be used for stabilization of the *Shimmer3* during calibration. Due to the rounded design of the *Shimmer3* enclosure, calibration should not be carried out without the calibration stand, as this will significantly affect the accuracy.



Figure 3-13 Shimmer3 Calibration Stand

To use the *Shimmer3 Calibration Stand*, simply remove the strap clips from the *Shimmer3* and insert the device into the stand using the clip slots, as shown in Figure 3-13. Ensure that the plastic clip inserts on the stand are securely inserted into the *Shimmer3* clip slots and that that user button is facing upwards, as illustrated.

### 3.5. Maintenance

#### 3.5.1. Cleaning

**Warning:** The *Shimmer3* enclosure is not waterproof and should never be submerged or saturated with fluids during operation or cleaning.

You should perform a periodic wipe-down of the case with an antiseptic wipe or, according to the standard operating procedure used on any piece of equipment in the place of operation. The external connector should be swabbed with a fine brush.

If you are using Shimmer in the presence of biohazards, treatment with a disposable wrap or cover is required according to best practices. Biohazard contamination will void warranty and contaminated devices returned to Realtime Technologies or any Shimmer address will be disposed of in accordance with applicable laws.

Replacement cases are available for purchase.

### 3.5.2. Inspection

The battery should be periodically inspected, at least weekly. Due to the unpredictable usage patterns of a research device, premature aging or failure may occur. If the battery seems "puffy" to the extent that it is impacting the fit of the enclosure (>1mm) or the integrity of the battery pack has been compromised by a puncture or abrasion you should contact customer support immediately for service.

### 3.5.3. Battery Replacement

Please note that any modification to the Shimmer hardware, while the device is within warranty, by any person/organization other than Shimmer will void said warranty.

The Shimmer units are supplied with a 3.7V 450mAh re-chargeable Lithium Polymer battery but the design supports both Lithium-Ion/Lithium-Poly cell chemistry as well as lithium coin cells and alkaline batteries. The battery should only be replaced by qualified personnel. Shimmer offers a battery replacement service or, alternatively, a battery replacement kit with an instruction manual and video. For further details contact [info@shimmersensing.com](mailto:info@shimmersensing.com).

The Shimmer uses a diode wired-OR to prevent device damage from reversed battery leads and allow operation from external power while charging.

The Texas Instruments LM3658D Smart Li Charger is used for battery management. The LM3658D implements a multi-phase charge profile including battery conditioning and overcharge protection. The default *Rset* resistor value of 22.1kΩ provides conservative 125mA charge limiting. The included 450mAh battery pack includes secondary failsafe protection against over/under voltage and over-discharge - all user-selected or installed batteries must provide secondary failsafe protection. The maximum discharge current on the supplied battery is 3.360A, a rate far exceeding expected conditions for sensing applications.

There is no limit on battery capacity but the charger has a safety circuit and will time-out after 6.16hrs. Due to the charge current being preset at 125mA the max charge capacity is 770mAh. The charge timer can be reset by removing the Shimmer, waiting for about 15 seconds and then reinserting. With large capacity batteries, Shimmers should be turned off while charging to reduce current loss from BT radio or other active components. Note that for *Shimmer3* the charging LED indicator does not represent the charging state when the Shimmer is switched off.

---

**Warning:** Never place LiPo batteries in parallel. There is a risk of fire in that configuration. As an alternative you should buy a larger capacity battery. The battery must include a safety PCB. A good source for these, in the USA, is <http://www.powerstream.com/li-pol.htm> (e.g. GM053048-PCB).

#### **3.5.4. Disposal**

**Warning:** Never expose Shimmer devices to excessive heat or an open flame.

Shimmer devices should be disposed of like other rechargeable devices. They should never be thrown away in the trash without first removing the battery. Lithium-Ion/Polymer batteries are classified as hazardous substances in most municipalities and should be disposed of according to local law or practice.

## 4. Software

Shimmer software offerings can be classified into two main categories:

- *Shimmer Software Applications* – stand-alone applications designed to meet the needs of Shimmer users, primarily in the area of data capture and *Shimmer Software*.
- *Development tools* - provided to customers who wish to develop their own software applications.

The sections below provide high level overviews of both Shimmer Software Applications and Software Development tools.

### 4.1. Software Applications

This section provides a brief introduction to the suite of *Shimmer Software Applications*.

In addition to the summary below, further details on each application can be found in the *Documentation/Software Application User Manuals* folder of the *Shimmer User Resources* distribution. A copy of each application can be installed from the installation files located in the folder, *Software Solutions*. The most recent versions of the user manuals and applications can also be downloaded from the [Shimmer website](#).

#### 4.1.1. Software for Logging Data to SD card

##### *Consensys*



*Consensys* is an integrated software solution for managing your *Shimmer3* devices. This solution merges several Shimmer software applications into a single software package. *Consensys* currently has four core features including: *Shimmer3* firmware programming; *Shimmer3* configuration through UART (via a Dock or Base) or over Bluetooth; Multi-Shimmer synchronisation<sup>4</sup>; data management for

---

<sup>4</sup> When used in combination with either SDLog v0.14.0 or later or LogAndStream v0.8.0 or later.

Shimmer data captured over Bluetooth and/or to the Shimmer SD card. *Consensys* streamlines management of your *Shimmer3* devices and simplifies experiment configuration.

The *Consensys* software solution contains two software applications, *ConsensysBASIC* and *ConsensysPRO*.

*ConsensysBASIC* is a free application that provides:

- a) Single Shimmer management.
- b) Basic visualisation of data that is streamed over Bluetooth from one Shimmer to the PC.
- c) Recording data that are streamed over Bluetooth from a single Shimmer to the PC into a database.
- d) Importing data recorded onto the microSD card of a single Shimmer into a database.
- e) Export data from the database for review in third party applications.

*ConsensysPRO* is a paid application that requires a license to run:

- a) All features of *ConsensysBASIC*
- b) Multiple Shimmer management.
- c) Event marking for annotating data.
- d) Off-line and on-line data processing algorithms.
- e) Enhanced data visualisation over Bluetooth.
- f) Add data descriptions for further data contextualization.

You can trial *ConsensysPRO* free of charge for a 30 day period (select TRY IT FREE when the software starts up)!

Using *Consensys*, users can easily manage their *Shimmer3* devices from within the application itself. The application will automatically download the latest firmware updates to help ensure your Shimmers are kept up-to-date.

A key feature of *Consensys* is the ability to easily configure multiple Shimmers in an experiment simultaneously. Once the experiment is setup using the intuitive user interface, the process of saving the configuration to each of the Shimmers is automated (configuring 15 or more Shimmers takes under 75s).

*Consensys* is designed to work with the *Consensys Base* hardware which allows users to easily configure up to 15 Shimmers per base device simultaneously. *Consensys* includes a database backend to allow the user to easily manage and organise the data recorded from all their *Shimmer3* devices. Post-data capture, the *Consensys* application along with the *Consensys Base* can be used to collate and organise data from multiple experiments and across multiple Shimmers. An export screen then allows users to output the data into their preferred file format.

#### **Other Core Features Include**

- Simple, intuitive application user interface.
- Simple Shimmer configuration screen allowing full configuration of the *Shimmer3*.
- Allows for simultaneous configuration of up to 15 Shimmers per *Consensys Base* in a fast and efficient manner (approximately 75 s for 15 Shimmers).



- Automatically keeps your *Shimmer3* devices up to date with the latest firmware releases.
- Automated transfer of data from Shimmer to PC.
- Data collated and stored in an SQL-based database.
- Data can be exported in uncalibrated or calibrated format to the users preferred output file type (e.g., a tab delimited text format for compatibility with Microsoft Excel, Open Office, MATLAB and most standard data manipulation programs).

### Multi Shimmer Sync for SD

This application has been deprecated since April, 2015 and replaced by *Consensys*. No further support will be provided for this software.

### ShimmerLog

This application has been deprecated since March, 2015 and replaced by *Consensys*. No further support will be provided for this (free) software.

## 4.1.2. Software for Streaming Data over Bluetooth

### Consensys

*Consensys* (see Figure 4-1) allows users to display and record data received from Shimmer devices streaming over Bluetooth (using LogAndStream firmware v0.8.0 or later). See section 4.1.1 for *Consensys* overview. Currently, *Consensys* is only supported on the Windows platform.

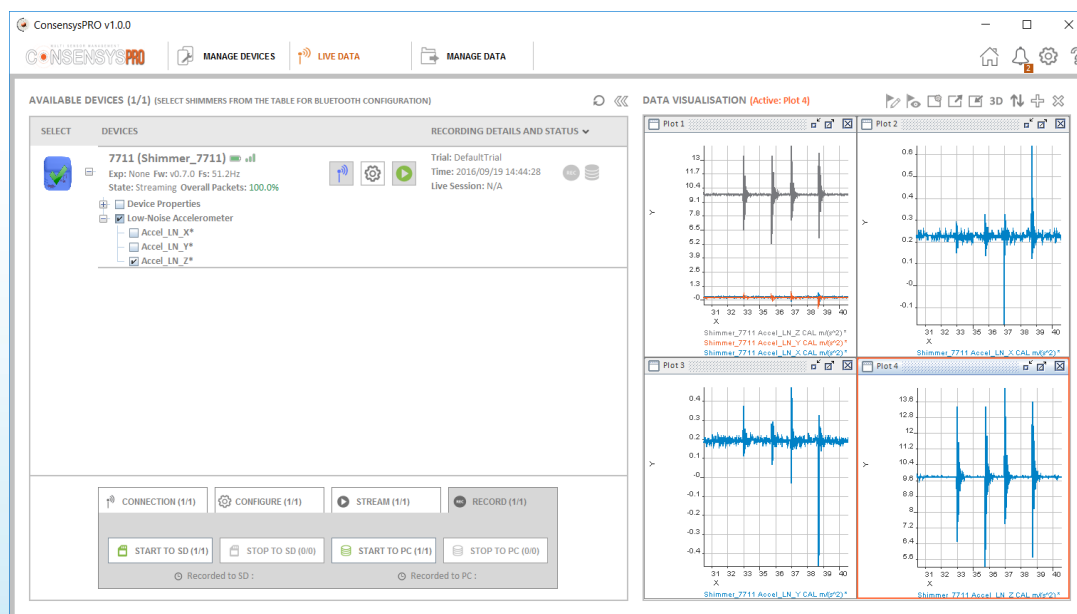

Figure 4-1 Consensys Software Application

### ShimmerCapture

*ShimmerCapture* (see Figure 4-2) allows users to display and save data received from Shimmer devices streaming over Bluetooth. Currently, *ShimmerCapture* is only supported on the Linux platform.

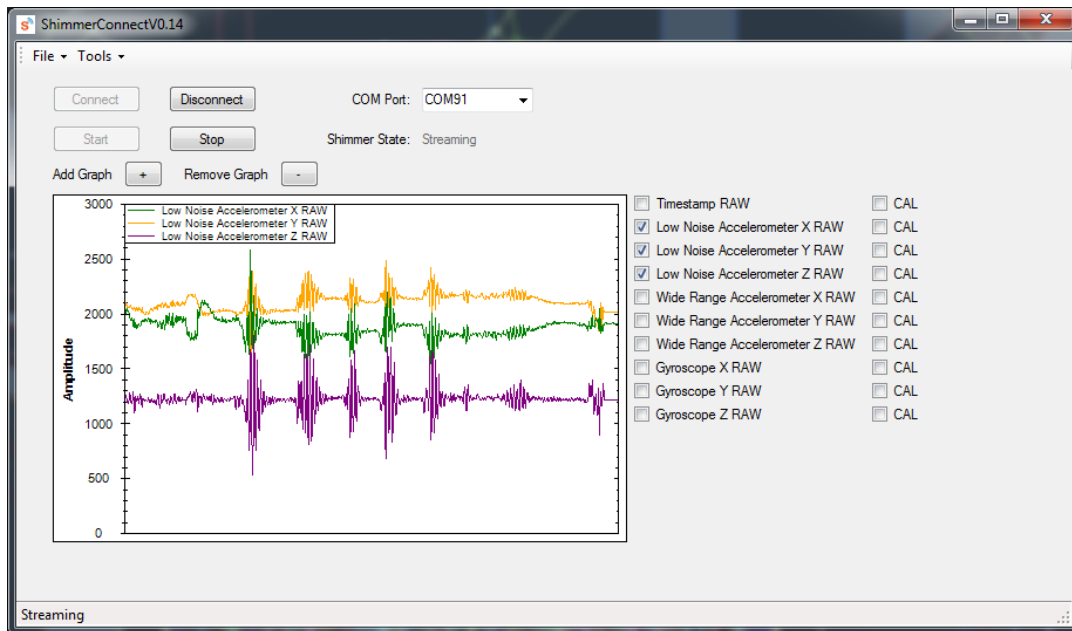

Figure 4-2 ShimmerCapture Software Application

Users can select the sampling rate, enable/disable specific sensors, enable/disable power monitoring, and change parameters such as the kinematic sensors' sensitivity. Once captured, the data can then be saved to a CSV file for further interpretation and analysis.

*ShimmerCapture* is not intended to be the answer to all host side application requirements but, instead, provides a quick-start application which, for many users, can act as a stepping stone for more advanced Shimmer applications. A number of design decisions have been focused on favouring simplicity over more advanced features and/or robustness, to allow the application to be as portable as possible. The C# source code for *ShimmerCapture* is available to Shimmer customers; see *Section 4.2.1* for more details.

### ***ShimmerCapture for Android***

*ShimmerCapture for Android* (Figure 4-3) is a mobile-device based application which allows users to configure a single Shimmer unit to stream data to an Android device over Bluetooth and save the data to file.

The application is ideal for entry level users looking for quick-start application to visualise and store data from the Shimmer platform.





Figure 4-3 ShimmerCapture for Android Software Application

### Multi Shimmer Sync for Android

*Multi Shimmer Sync (MSS) for Android* (Figure 4-4) is a mobile-device based application which allows users to configure multiple Shimmer units to stream data to an Android device over Bluetooth, as well as saving the time-synchronised data to a file.

The application is ideal for users looking to develop applications in mobile scenarios where simultaneous data capture from a number of units is required. *MSS (Android)* permits the user to configure multiple Shimmer units and can be used with the full range of Shimmer sensing modules. With a range of features and data capture tools, users can select sampling rate, detect dropped packets, save and load application settings for future use, annotate data, and name Shimmer units.



Figure 4-4 MSS for Android Software Application

## Multi Shimmer Sync for Windows

This application has been deprecated since October, 2015 and replaced by *Consensus*. No further support will be provided for this software.

### 4.1.3. Software for Calibrating sensors

#### 9DoF Calibration Application

The *Shimmer 9DoF Calibration for Windows* (Figure 4-5) and *Shimmer 9DoF Calibration for Android* (Figure 4-6) applications provide an automated procedure for calculating the calibration parameters for Shimmer’s integrated tri-axial accelerometer, gyroscope and magnetometer. The calibration parameters can be stored to the Shimmer on-board memory or to a file and can be recalled by other applications to provide calibrated sensor data.

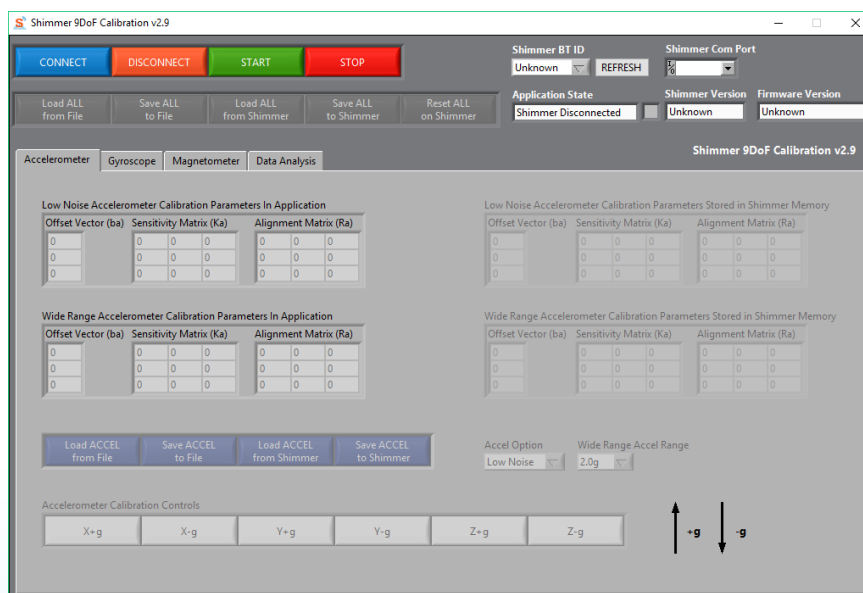

Figure 4-5 9DoF Calibration for Windows Software Application

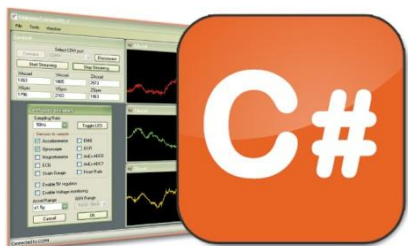

Figure 4-6 9DoF Calibration for Android Software Application

## 4.2. Software Development

This section provides a brief introduction to the suite of Shimmer Software Development tools, called the *Shimmer Instrument Drivers* (Shimmer IDs) and *Shimmer Application Programming Interfaces* (Shimmer APIs). The *Shimmer IDs* and *APIs* are libraries for software developers that allow for the rapid integration of the Shimmer platform into software applications being developed in C#, LabVIEW, MATLAB and Java/Android.

### 4.2.1. C#



The *C# API* includes the .NET based source code for the *ShimmerCapture* application (see *Section 4.1.2*). The code is the basis for an application which allows users to calibrate, display and save data received from Shimmer devices streaming over Bluetooth. The code is designed for usability and functionality, with a number of data capture parameters being configurable. C# developers can quickly integrate Shimmer devices into their applications by building on top of the *C# API*.

### 4.2.2. JAVA/Android

The *Shimmer JAVA/Android API* allows for the development of Android applications that require data to be streamed directly from Shimmer units to Android devices. The solution permits Shimmer users to easily interact with Shimmer units to configure, stream, display and log data on Android devices. The purpose of this *Shimmer API* is to reduce the development time for Shimmer developers on the Android operating system. The library includes a number of example applications. Built on top of the Android Bluetooth Library, the driver's object oriented design allows easy integration with other libraries.



### 4.2.3. LabVIEW

The *ShimmerSensing LabVIEW Instrument Driver Library* is a library of LabVIEW VI's designed to assist users of the *Shimmer2*, *Shimmer2r* and *Shimmer3* platforms in the development of Shimmer-based applications in LabVIEW. This *Shimmer ID* provides all the benefits associated with the LabVIEW development environment and incorporates a number of end-user functions specific to the Shimmer platform, as well as example applications. Extensive support documentation is available along with video demonstrations.

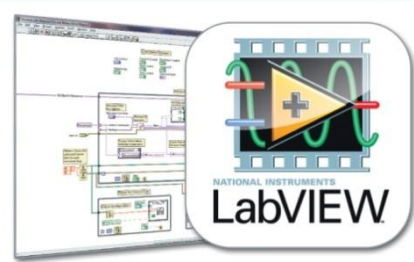

### 4.2.4. MATLAB

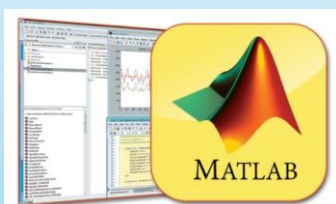

The *Shimmer MATLAB Instrument Driver Library* is an object oriented solution for Shimmer data capture in MATLAB. This *Shimmer ID* allows Shimmer data to be streamed directly to MATLAB and assists users of the *Shimmer2*, *Shimmer2r* and *Shimmer3* platforms in the development of Shimmer based applications in MATLAB.

---

Shimmer users will benefit from MATLAB's full range of tools including matrix manipulations, plotting of functions and data, implementation of algorithms, creation of user interfaces, and interfacing with programs written in other languages, including C, C++, Java, and Fortran. The code is extensively commented and includes a number of sample applications.

## 5. Firmware

At Shimmer we provide a range of stock firmware solutions for use on the Shimmer platform; however, a user is free to develop their own firmware solution should they wish to do so. Shimmer firmware solutions have been developed to ensure Shimmer users benefit from some of the most efficient and effective wireless sensing solutions available, availing of low power communications and a flexible, highly configurable framework. *Section 5.1* below outlines our existing Shimmer firmware solutions, whilst *Section 5.3* provides information on firmware development for Shimmer.

The *Consensys* application allows for the Shimmer unit to be programmed with the appropriate firmware solution when docked in the *Shimmer Dock* or *Consensys Base*. This process is explained in more detail in *Section 3.2.5*.

### 5.1. Firmware Solutions

Whilst *LogAndStream* and *SDLog* are complete firmware solutions, provided by Shimmer to support *Shimmer IDs*, *Shimmer APIs*, *Multi Shimmer Sync for Android* and *Consensys* software, the additional solutions described in this section are intended to help new users to become familiar with the Shimmer platform and to be a starting point for users who are developing their own custom firmware solutions.

#### 5.1.1. LogAndStream

*LogAndStream* firmware is a complete data recording solution which merges features from our previous *Shimmer3* firmware releases. The *LogAndStream* firmware facilitates logging of data from a *Shimmer3* to the on-board SD card while also providing the ability to simultaneously stream data over wireless connection to a Bluetooth-enabled PC. The firmware allows for full user configuration of the *Shimmer3* using a configuration file stored on the SD card, over Bluetooth using the provided *Consensys* software application and is also fully compatible with the Shimmer Instrument Drivers.

*LogAndStream* Firmware can be used with a *Shimmer3* device with a microSD card, with capacity up to 32Gbytes. For Shimmer compatibility the microSD card chosen must implement 1-bit SPI mode. The *Shimmer3* is shipped with a compatible microSD card. A *Shimmer Dock* or *Consensys Base* is required to allow access the SD card on the Shimmer from the PC for configuration of logging preferences and data transfer. Please note that legacy (black) Shimmer docks are not suitable for this purpose and a newer (white) dock is required.

The source code is also openly available for any able user who may wish to modify or customise it to their own needs or, indeed, to use it as the basis for a new firmware application; see *Section 5.3* for more details and resources for developing firmware.

#### ***Using the firmware***

The *LogAndStream* firmware provides a seamless integration of *SDLog* (*i.e.* logging *Shimmer3* data to an on-board microSD card) and streaming *Shimmer3* data back to "host" device over Bluetooth. The *LogAndStream* firmware has been designed such that a user can still utilise the *Shimmer3* in a purely *Bluetooth only* or *SDLog* mode if they desire – with the additional capability of doing both simultaneously.



A *Shimmer3* programmed with *LogAndStream* firmware can be in one of five states: *Idle*, *BT Connected*, *BT Streaming*, *BT Streaming + SD Logging* or just *SD Logging* - as shown in Figure 5-1. The active states form two operational branches from which the user can choose to operate the *Shimmer3* device - one initiated by a Bluetooth connection (blue shaded area in Figure 5-1) and the other based on SD Logging operation (orange shaded area in Figure 5-1).

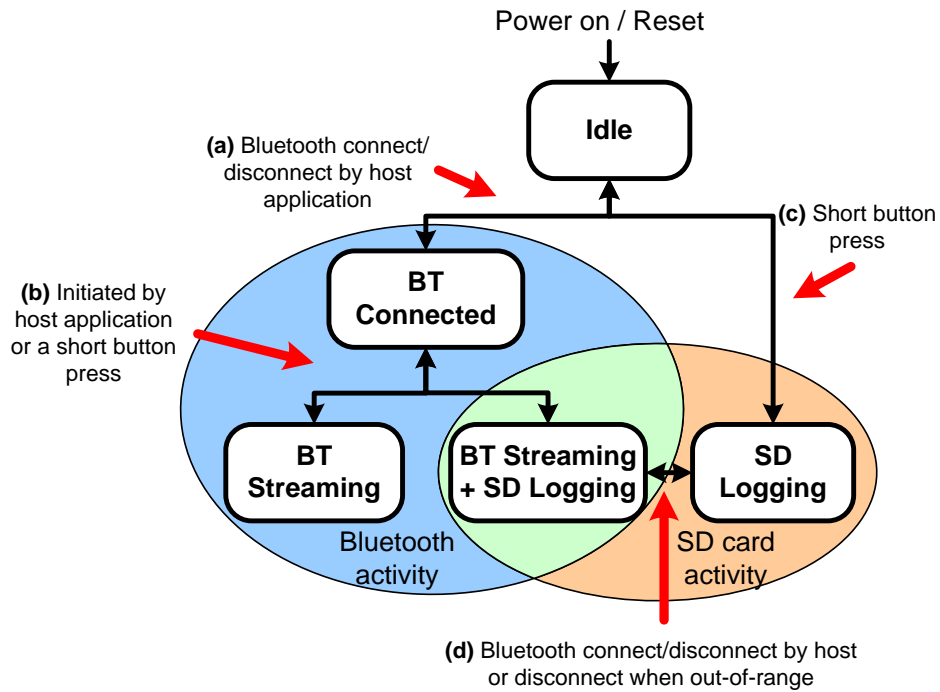

Figure 5-1 *LogAndStream* firmware operational hierarchy.

### ***LogAndStream* firmware LED Indicators**

The *Shimmer3* has five LEDs in two locations as shown in Figure 2-1: the lower LED location (location A) which contains the green (b), yellow<sup>5</sup> and red LEDs; and the upper LED location (location B) which contains the green (a) and blue LEDs.

The two upper LEDs are used to indicate state of operation for the *LogAndStream* firmware. The status of each depends on whether the *Shimmer3* is in a docked or undocked state, as shown in Table 5-1 below.

<sup>5</sup> Note that what is referred to as the yellow LED may appear orange to some users.







		LED Pattern	Description
Docked or Undocked	Standby		Blue 0.1s ON/2s OFF
	Bluetooth Connected		Blue Solid ON
	Streaming only		Blue 1s ON / 1s OFF
	RTC not set		0.1s Blue/0.1s Green
Undocked only	Configuring		Green 0.1s ON/ 0.1s OFF
	SD error		0.1s Red/0.1s Yellow
	Logging only		Green 1s ON / 1s OFF
	Streaming and Logging		1s Blue/1s Green

Table 5-1 LED indicators specific to LogAndStream firmware (undocked and docked).



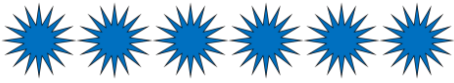
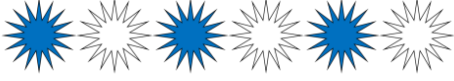

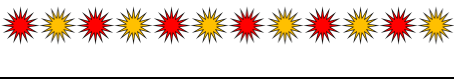
		LED Pattern	Description
Docked or in Multi Charger	Full Charge		Green Solid ON
	Charging		Yellow Solid ON
Undocked	Full Charge		Green 0.1s ON/5s OFF
	Medium Charge		Yellow 0.1s ON/5s OFF
	Low Charge		Red 0.1s ON/5s OFF

Table 5-2 Power status LED indicators for Shimmer3 firmware (undocked and docked).

**Note:** The SD error LED sequence is present in LogAndStream\_v0.8.0 and later. Older versions of LogAndStream combine both SD and RTC errors into a 0.1s Blue/0.1s Green LED flashing sequence.

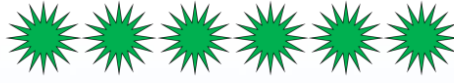
**Note:** The Shimmer unit should never be placed in the dock while the operation status LED's indicate that it is configuring as this may cause a file-system error. Once configuration has begun, you must power off or reset the Shimmer unit before docking.

**Note:** It is not recommend to place the *Shimmer3* unit in the dock while it is logging data as this can cause SD card access problems. Once logging has begun, you must power off or reset the *Shimmer3* unit before docking.

### 5.1.2. SDLog

*SDLog* Firmware is a firmware image which allows logging of data from a Shimmer to the on-board SD card. The firmware allows full user configuration of the Shimmer via a configuration file, stored on the SD card. Many useful features, such as time synchronisation among multiple Shimmer units, start/stop logging on one or more devices by a single button press, and user-defined naming of devices, are enabled by this firmware image.

*SDLog* Firmware is fully compatible with *Consensys* software. *SDLog* Firmware can be used with a *Shimmer3* device with a microSD card, with capacity up to 32Gbytes. For Shimmer compatibility the microSD card chosen must implement 1-bit SPI mode. The *Shimmer3* is shipped with a compatible microSD card.

A *Shimmer Dock* or *Consensys Base* is required to allow access the SD card on the Shimmer from the PC for configuration of logging preferences and data transfer. Please note that legacy (black) Shimmer docks are not suitable for this purpose and a newer (white) dock is required.

#### ***Using the firmware***

To use the *SDLog* Firmware, the user must provide the desired configuration parameters of each Shimmer. The configuration parameters are saved in a configuration file, named *sdlog.cfg*, from which they will be loaded by the Shimmer at initialisation. The configuration file is read every time a new logging session is started on the Shimmer. To change the configuration, modify the *sdlog.cfg* file and reboot the Shimmer (there is no need to reprogram). The configuration file allows configuration of all firmware features, including which sensors are enabled, sampling rate, sensor sensitivity parameters and synchronisation options.

It is recommended to use the *Consensys* software to avoid errors in writing the configuration file. However, it can be written in any text editor and saved to the SD card without the software application; refer to the *SDLog for Shimmer3 Firmware User Manual* for further details. *Consensys* is available in the *Shimmer User Resources* distribution as well as for download from the Shimmer website (<http://www.shimmersensing.com>).

#### ***SDLog firmware LED Indicators***

The *Shimmer3* has five LEDs in two locations: lower location A (green, yellow and red); upper location B (green , blue), as shown in Figure 2-1.

The LEDs in Location A are used to indicate battery charge status, as outlined in Table 5-3.





		LED Pattern	Description
Docked or in Multi Charger	Full Charge		Green Solid ON
	Charging		Yellow Solid ON
Undocked	Full Charge		Green 0.1s ON/5s OFF
	Medium Charge		Yellow 0.1s ON/5s OFF
	Low Charge		Red 0.1s ON/5s OFF

Table 5-3 SDLog Battery Charge Status Indication

The LEDs in Location B are used to indicate operation status, as outlined in Table 5-4.

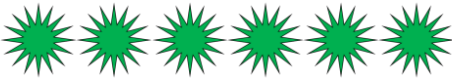
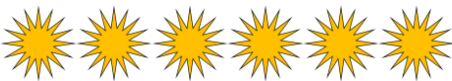





		LED Pattern	Description
Docked or Undocked	Standby		Green 0.1s ON/2s OFF
	Radio On		Blue Solid ON
	Synchronising with another Shimmer		0.1s Blue/0.1s Green
	RTC not set		0.1s Blue/0.1s Green
Undocked only	Configuring		Green 0.1s ON/ 0.1s OFF
	SD error		0.1s Red/0.1s Yellow
	Logging		Green 1s ON / 1s OFF

Table 5-4 SDLog Operation Status Indication

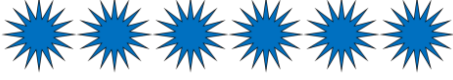
**Note:** The SD error LED sequence is present in SDLog\_v0.14.0 and later. Older versions of SDLog combine both SD and RTC errors into a 0.1s Blue/0.1s Green LED flashing sequence.

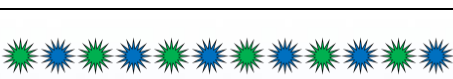
**Note:** The Shimmer should never be placed in the Dock while the operation status LED's indicate that it is configuring as this may cause a file-system error. Once configuration has begun, you must power off or reset the Shimmer before docking.

**Note:** Placing the Shimmer in the Dock while it is logging data is not recommended as this can cause SD card access problems. Make sure that logging has stopped before docking the device.

**Note:** Logging and other SD card related operations are not carried out while the device is on the dock.

### ***Further information***

For a complete understanding of the *SDLog* Firmware, including important limits on allowed sampling frequency for various sensor configurations, please refer to the *Shimmer3 SDLog Firmware User Manual*, available in the *Shimmer User Resources* distribution as well as from the download section of the Shimmer website (<http://www.shimmersensing.com>).

### **5.1.3. Other sample solutions**

#### ***Blink***

This simple application blinks the five LEDs on the *Shimmer3*.

#### ***Sleep***

This simple application puts the *Shimmer3* into a low power state.

## **5.2. Programming a Shimmer**

To program a Shimmer, you need a *Shimmer Dock* or a *Consensys Base* and must have previously completed the *USB Serial Converter Driver Installation* procedure outlined earlier in section 3.2.1 of this document. Two methods for programming your device are outlined below; choose the one most suited to your configuration and preference.

### **5.2.1. Programming in Windows using *Consensys***

The *Consensys* application can be used in Windows to program the Shimmer with pre-compiled firmware images. *Consensys* is available from the *Shimmer User Resources* or for download from <http://www.shimmersensing.com>.

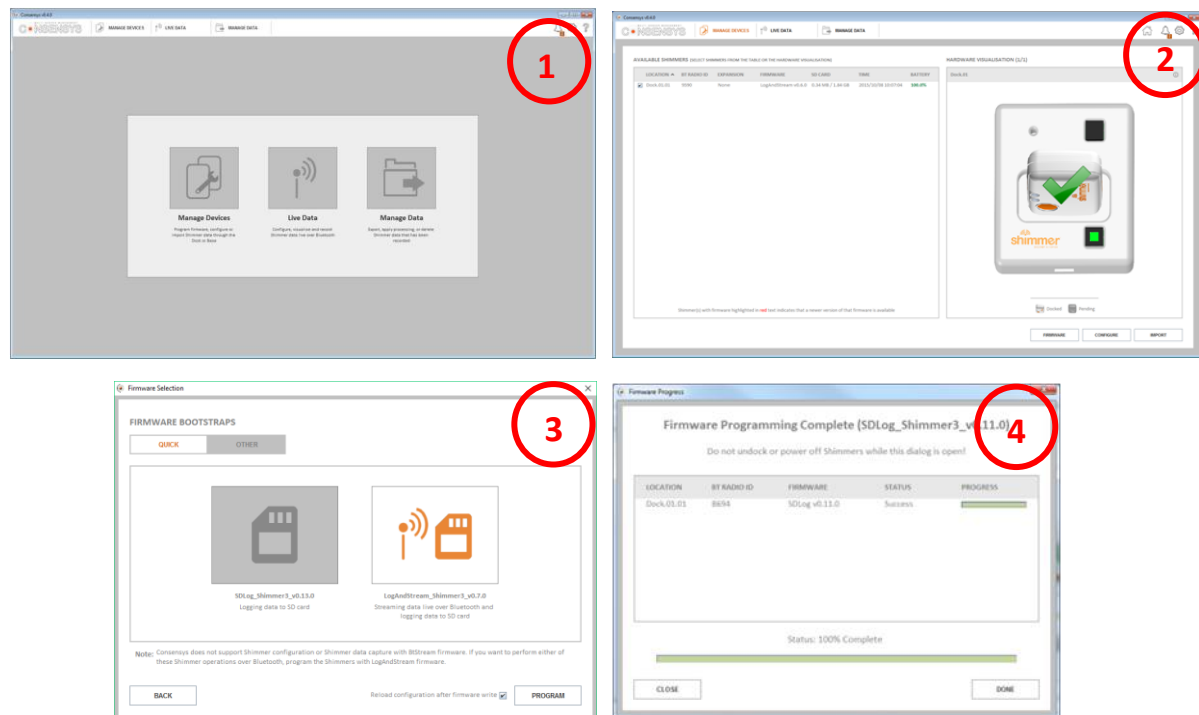

Figure 5-2 Shimmer3 firmware programming using Consensys

Programming firmware onto a Shimmer using Consensys is a four step process:

1. Launch Consensys and select the *MANAGE DEVICES* tab.
2. Insert your Shimmer (ensure it's powered on) into a Dock or Consensus Base; select the Shimmer from *AVAILABLE SHIMMERS* table or from the *HARDWARE VISUALISATION* graphic and then press the *FIRMWARE* button.
3. Select one of Shimmer's precompiled firmware images provided on the *QUICK* tab or you may choose to load a firmware image (a file with a *.txt* extension) from your PC into Consensys on the *OTHER* tab. Press the *PROGRAM* button to start programming the Shimmer with the selected firmware.
4. Progress indicators highlight the status of the firmware programming. When programming is complete, the progress bar will be filled to 100% and the *DONE* button will be enabled. See expected Shimmer LED behaviour for provided firmware images in section 5.1.

### 5.2.2. Programming under Linux

Programming of the *Shimmer3* in Linux requires a number of prerequisites to be completed; these are listed below. Steps 1 to 4 need only be run once for installation purposes.

1. Obtain the latest version of the MSP430 Tools library (actively maintained at <https://code.launchpad.net/python-msp430-tools>) using Bazaar by using the following command line:

```
bzr branch lp:python-msp430-tools
```

2. Obtain the patch "bsl5uart\_fixes\_2.patch" (described at <https://bugs.launchpad.net/python-msp430-tools/+bug/1258574> ) using the following command line:

```
wget https://launchpadlibrarian.net/160212768/bsl5uart_fixes_2.patch
```

3. Copy the patch to the python-msp430-tools directory and apply the patch as follows:

```
patch < bsl5uart_fixes_2.patch
```

If file path errors appear, give the path **msp430/bal5/bsl5.py** followed by **msp430/bsl5/uart/py** in response to the errors.

4. Install the MSP430 Tools library as follows:

```
sudo python setup.py install
```

5. To load the Bootstrap code to the *Shimmer3*, use the command listed below. This command assumes that the Bootstrap image "*S3\_Blink.txt*" is in the folder you are running from and the programming port of the dock is *"/dev/ttyUSB0"* – change as necessary):

```
python -m msp430.bsl5.uart --invert-test --invert-reset -p /dev/ttyUSB0 -r -e -i titext -P S3_Blink.txt
```

6. Remove the *Shimmer3* from the *Shimmer Dock* and cycle the power to reset and run the freshly loaded firmware.

Note that the reset function does not operate as expected but programming will still result in a success - hence the need to undock the *Shimmer3* and cycle the power.

## 5.3. Firmware Development

It is recommended that design, implementation, testing and validation of Shimmer embedded software (firmware) be done in Code Composer Studio™ from Texas Instruments. Alternatively, any compiler that supports the MSP430F5437A can be used (e.g. IAR embedded workbench, Rowley Crossworks, MSP430GCC). Shimmer application code examples for Code Composer Studio™ are actively maintained at <https://github.com/ShimmerResearch/shimmer3>.

Current functionality includes:

- microSD flash storage.
- FAT file system.
- Bluetooth configuration, connection management and streaming data transfer.
- Time and clock configuration.
- Peripheral control and configuration.
- Power supply monitoring.

### 5.3.1. Setting up a build environment

To develop firmware for *Shimmer3*, you will need the Code Composer Studio™ IDE from Texas Instruments or another compiler that supports MSP430F5437A (examples listed above). Furthermore, a Flash Emulation Tool (FET), such as the MSP-FET430UIF (or equivalent) from Elpotronic or another manufacturer and a Shimmer Developer Board are recommended for developers but not essential unless debug capability is needed.

### 5.3.2. Getting and updating the Shimmer source code

All Shimmer source code is hosted in a Github repository. Git is an open source version control system that facilitates software configuration management. It is used by many software developers to manage changes within their source code tree and provides the means to store the current version of a source code element (e.g. a \*.c source file) and it records all changes that have occurred to that source code. For further details on Git, follow the documentation link at <http://git-scm.com>; a download link can be found on the same website.

To clone a copy of the *Shimmer3* repository to a new directory, use the following command:

```
git clone https://github.com/ShimmerResearch/shimmer3
```

To update the repository, navigate to the appropriate folder and run the following two commands:

```
git fetch origin  
git pull origin
```

In the *Shimmer3* repository, you will find the source code for all the sample solutions mentioned in *Section 5.1*.

### 5.3.3. Getting started with Code Composer Studio™

The programming language for the *Shimmer3* is C. Texas Instruments provide training material helping new users to get up-to-speed with Code Composer Studio on their Wiki: [http://processors.wiki.ti.com/index.php/Category:CCS\\_Training](http://processors.wiki.ti.com/index.php/Category:CCS_Training).



As mentioned previously, if in-program debugging is not required, Code Composer Studio can be configured to create an output flash image that can be loaded to a *Shimmer3*, using the *Consensys* application and *Shimmer Dock* or *Consensys Base*. To ensure this option is selected, complete the following steps:

1. With the project selected in Code Composer Studio, go to the "Project" menu and select "Properties".
2. As shown in Figure 5-3, select the "Build" menu in the left panel and then select the "Steps" panel on the right.
3. Ensure that "Create flash image TI-TXT" is listed in the "Description" box. If this is not the case, select it from the "Apply Predefined Step" drop down menu as shown.
4. Finally press the "Apply" button to save the changes.

An output TXT file with the same name as the project will then be created within the "Debug" directory of the project when the project is built. This is the file that can be loaded to the *Shimmer3* through the *Consensys* application.

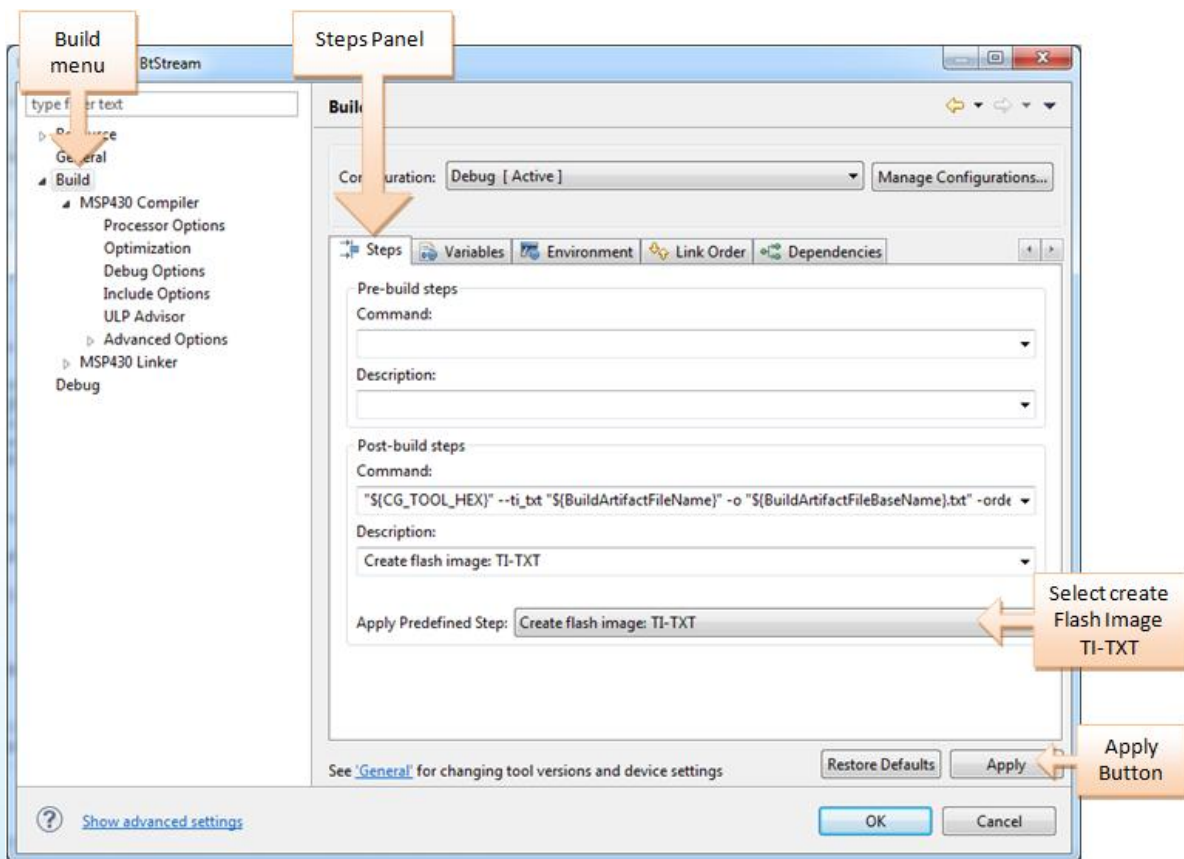

Figure 5-3 Creating an output TXT file using Code Composer for custom firmware programming with the Consensys application.

## 6. Hardware

This section provides an overview of the Shimmer hardware architecture and discusses the hardware sub-systems contained within. For *Shimmer3 mainboard* detail, debug and testing procedures and pin-out information, please refer to the Appendices of this document.

### 6.1. Shimmer Hardware Overview

Figure 6-1 presents a block diagram of the *Shimmer3 mainboard* with core components and interconnections between integrated devices illustrated.

The central element of the platform is the low-power MSP430F5437A microprocessor which controls the operation of the device. Nearly every feature of the CPU is exercised in the Shimmer implementation. The CPU configures and controls various integrated peripherals through I/O pins, some of which are available on the internal/external-expansion connectors. The CPU has an integrated 16-channel 12bit analogue-to-digital converter (ADC) which is used to capture sensor data from the low noise accelerometer, battery, or sensor expansions, such as GSR, Bridge Amp and Proto 3 Deluxe. The external expansion also allows communication to and from the mainboard using the docking station.

The Shimmer board has a built in microSD Flash socket for additional storage and has five light-emitting diodes (LED) for display purposes. It also has an on-off switch and a software-defined user button. For wireless data streaming, the platform is equipped with a Bluetooth radio module and has the capacity for an additional alternative radio.

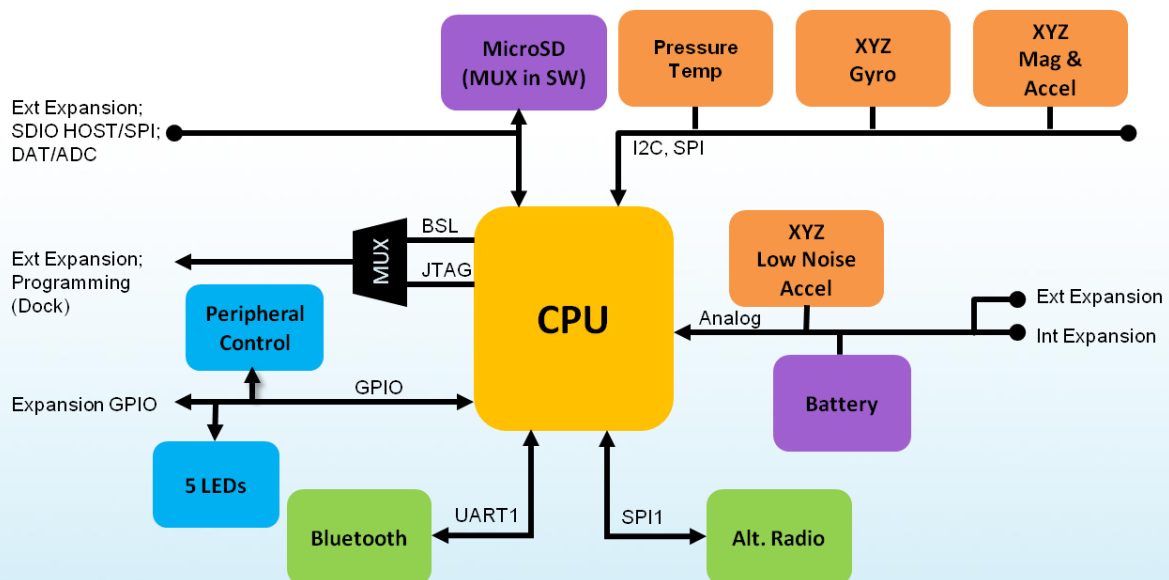

Figure 6-1 Shimmer3 Core Component Block Diagram

### 6.2. Hardware Sub-System Detail

Functional descriptions of communication, microSD storage and power subsystems are presented in this section. For the purposes of debug and testing, lower level component information can be found in the appendices of this document. Vendor datasheets and application notes are the best sources of

detailed operational information, training material and errata on components designed into Shimmer.

### 6.2.1. Radio Communication

One of the key functions of the Shimmer board is its ability to communicate as a wireless platform. Shimmer uses a Bluetooth Radio module.

#### ***Bluetooth (IEEE 802.15.1)***

Bluetooth is a low-cost, low-power, robust, short-range wireless communication protocol which was initially founded by Ericsson in 1994 to replace traditional mobile phone and computer cables with wireless links. It operates in the license free 2.4 GHz ISM (industrial, scientific, medical) band with a short range (power-class-dependent: 1 metre, 10 metres, 100 metres) transceiver in each device. With the introduction of the (EDR) Enhanced Data Rate feature [1], devices can communicate with each other at up to 3Mbps. The Bluetooth special interest group (SIG) was founded in 1998 by companies such as Ericsson, Nokia and Intel and the core system consists of an RF transceiver, baseband and protocol stack. Bluetooth radios are designed for busy environments with many users. Up to eight Bluetooth devices can communicate together in a network called a piconet. The piconet is a point to multipoint network consisting of one master and up to seven slave devices. Multiple piconets can coexist and join together to form scatternets. Bluetooth uses 79 1MHz channels to transmit data. Interference between other ISM band devices (802.11 and 802.15.4 devices) and other Bluetooth piconets is minimised using frequency hopping spread spectrum (FHSS), where the carrier is rapidly switched (hops) among the 79 available channels. The frequency hopping sequence is controlled by the master within the piconet. Other Bluetooth interference reduction techniques include adaptive power control, Channel Quality Driven Data Rate (CQDDR) and Adaptive Frequency Hopping (AFH) [2]. Extensive documentation and analysis of Bluetooth and its applications can be accessed from the Bluetooth SIGs website at [www.Bluetooth.org](http://www.Bluetooth.org).

Microsoft Windows currently only supports a single Bluetooth Piconet, limiting users to seven simultaneously attached devices. Linux support multiple Piconets and exposes the entire Bluetooth stack in open source software, for users interested in doing advanced or special purpose development with Bluetooth.

The Shimmer platform uses the Roving Networks RN-42 [3] Class 2 Bluetooth module to communicate via an integrated 2.4GHz antenna. This module was found to be well engineered and very configurable [4], reliable and robust. This module contains a full Version 2 Bluetooth Protocol Stack and supports the Serial Port Profile which facilitates rapid application development. The Bluetooth module is connected to the MSP430 directly via the USART1 serial connection. It can also be controlled by ASCII strings over the Bluetooth RF link. The RN-42 has a range of more than 10 metres (33 feet) and the transmitted power can be adjusted depending on the application distance. The system has seventy-nine channels with channel intervals of 1MHz and offers a robust secure link via frequency hopping spread spectrum (FHSS) and error correction schemes. Users can expect to communicate with the Shimmer USART at speeds up to 230kbaud, with 115kbaud as the default and recommended value.



## 6.2.2. MicroSD Card Storage

### **MicroSD Card Socket**

The *Shimmer3 mainboard* contains a microSD card socket to incorporate extra memory resources. For Shimmer compatibility, the microSD card chosen must implement 1-bit SPI mode. Please refer to the *Shimmer3 MicroSD Media Guide* for more information on microSD card compatibility. A compatible SD card is shipped with each *Shimmer3*.

### **Host Data bypass Functionality**

To improve usability, Shimmer incorporates a wide bandwidth analogue MUX and tri-state logic buffering on certain signals routed to the external connector to provide direct and immediate access to flash memory using an external SD-flash card controller (SDHOST) for high-speed data transfer. Shimmer Applications that use the microSD card will require firmware that allows for the SD specification's requirement of a power-cycle to change from SPI mode (the card talking to the MSP430) back to SDIO mode (the card is controlled by the USB flash media controller). Power-cycling the card requires explicit control of the card's interface pins, setting them to *LOW* (zero Volts).

The Host Data Bypass implementation has been simplified when compared to prior generation sensor platforms such as *Shimmer2r*. When a firmware application detects that the Shimmer is docked, it can complete pending activities, power cycle the flash media (including lowering all SPI pins going to the media), reconfigure the data path and the assert a media-detect signal to the host computer via a USB flash media controller peripheral.

**Always use a *Shimmer Dock v3* (or higher) for best performance.**

**Earlier docks required a logic timing-critical scheme, which has been deprecated.**

The Host data activity indicator on the USB Reader dock, presented earlier in this manual, provides helpful status information.

## 6.2.3. Power

The Shimmer units are supplied with a 3.7V 450mAh re-chargeable Lithium battery but the design supports both Lithium-Ion/Lithium-Poly cell chemistry and lithium coin cells and alkaline batteries. Device safety is maintained by integrating battery polarity protection, charge monitoring and failsafe battery over/under voltage and over-discharge limits in common mobile environments and while AC-powered. Refer to the *Section 3.5.3* for further details on use of replacement batteries with Shimmer.

### **Power States**

A sliding switch is used to control board power states.

Soft power switching is provided for the Bluetooth radio module, temperature compensated crystal oscillator, FFC expansion (Radio Peripheral) and microSD socket (see *Host Data bypass Functionality* discussion above for more information on microSD card power control). Other modules have integrated shutdown functionality.

Shimmer’s on-board regulator can provide 100mA continuous current and tolerates surges until a thermal limit is reached. Expansion devices must be current limited or have independent regulation running off the PV\_REG expansion pin. Exceeding the 100mA limit of the regulator, whilst possible, is not recommended without detailed analysis and qualification of both electrical and thermal design margin.

### **Battery Life**

The *Shimmer3* design goal for use as a long-term motion capture device is 1-14 days of operating life from a 450mAh cell, while acquiring multichannel data with periodic radio communication. Using the standard Shimmer battery (a 3.7V 450mAh re-chargeable Lithium battery), device operating time will depend on a number of factors such as whether or not the radio is enabled, which sensors are enabled and what sampling frequency is used.

Sensors Enabled	Sync?	Sampling Rate	Average Battery Life (hh:mm)
Accel (wide range)	No	10.24 Hz	282:00
Accel (wide range)	No	1024 Hz	111:00
Accel (wide range)	Yes	1024 Hz	65:00
Accel (low noise)	No	1024 Hz	113:00
Accel (wide range) Gyro Mag (LSM303DLHC) Battery, Ext A7, Ext A6, Int A15	No	256 Hz	69:00
Accel (wide range) Mag (LSM303DLHC) Battery, Ext A7, Ext A6, Int A12	No	1024 Hz	44:00
Accel (wide range) Mag (LSM303DLHC) Battery, Ext A7, Ext A6, Int A12	Yes	1024 Hz	39:00
ECG	No	256 Hz	170:00
GSR PPG	No	256 Hz	175:00

*Table 6-1 Shimmer3 Battery Life Estimation Table (SDLog)*

Sensors Enabled	Sampling Rate	Average Battery Life (hh:mm)
Accel (low noise) Battery	1024 Hz	15:00
Accel (low noise) Battery	51.2 Hz	17:50
Accel (wide range) Gyro Mag (LSM303DLHC) Battery.	51.2 Hz	14:15

Table 6-2 Shimmer3 Battery Life Estimation Table (LogAndStream – Bluetooth only)

Table 6-1 and Table 6-2 outline some example battery life estimation values for data capture, derived from laboratory testing, using *SDLog* and *LogAndStream* (with Bluetooth streaming only), respectively. The tables can also be used to estimate the battery life for a configuration not listed. Note that users might experience some variation in battery life duration – this being dependent upon the number of charge cycles a battery has undergone in its lifetime.

The *Shimmer IDs*, *Shimmer APIs* and software applications provide calibrated data, as well as raw data. If you are developing a solution that does not avail of those options, you will need to calibrate your raw ADC channel values to obtain a meaningful battery voltage reading.

Remaining Capacity	Voltage	Remaining Capacity	Voltage
0.0%	3.2	53.1%	3.8034
5.9%	3.627	57.0%	3.8106
9.8%	3.645	61.0%	3.8394
13.8%	3.663	64.9%	3.861
17.7%	3.681	68.9%	3.8826
21.6%	3.699	72.8%	3.9078
25.6%	3.717	76.7%	3.933
29.5%	3.7314	80.7%	3.969
33.4%	3.735	84.6%	4.0086
37.4%	3.7386	88.5%	4.041
41.3%	3.7566	92.5%	4.0734
45.2%	3.771	96.4%	4.113
49.2%	3.789	100.0%	4.167

Table 6-3 Battery Capacity based on Battery Voltage

Equation 1, below, defines how to convert the raw battery measurement values to Volts. Equation 2 calculates the battery voltage by multiplying the calibrated voltage output by two (required due to use of voltage divider in hardware; contact Shimmer support if further information is required).

$$\text{calibratedBatteryData} = (\text{rawBatteryData} - \text{offset}) \cdot \left(\frac{1}{4095}\right) \cdot \left(\frac{V_{\text{ref}}}{\text{gain}}\right) \quad \text{Equation 1}$$

where  $\text{offset} = 0$ ,  $V_{\text{ref}} = 3V$ ,  $\text{gain} = 1$ .

$$\text{Battery Voltage} = \text{calibratedBatteryData} * 2 \quad \text{Equation 2}$$

In order to estimate the remaining battery capacity you can use Table 6-3 which has been derived from information provided by the battery manufacturer. Note that the number of charge cycles a

battery has undergone in its lifetime will influence the accuracy of the remaining capacity estimates. According to the battery manufacturer the worst case is 75% of full capacity after 300 cycles.



## 7. Troubleshoot

**Note:** Further troubleshoot information pertaining to non-mainboard hardware and software can be found in the additional User Guides/Manuals.

### ***Shimmer Won't Connect over Bluetooth***

- Verify that the Shimmer has been programmed with Bluetooth (BT)-enabled firmware (e.g. *LogAndStream*).
- Verify Shimmer is within range of host side device and has a line of sight.
  - Whilst the Shimmer BT radio has a range of 10m, the range of your host side BT radio may vary and should be verified. Bluetooth communication doesn't necessarily require line of sight; however, for initial connection, it is recommended.
- Verify that there are not any issues with a low or problematic battery.
  - Place the Shimmer in a powered charging dock; if the cause of the connection issues is the Shimmer battery, then placing the Shimmer in the dock should rectify the issue.
- Make multiple connection attempts.
  - Making multiple connection attempts may be required for the following reasons:
    - Paging Inquiry - When the Shimmer is not connected the paging inquiry window on the BT radio defaults to 320ms (out of 2.56s) so the Shimmer is only 'listening' for a connection 12.5% of the time.
    - FHS (frequency hopping synchronization) - When a BT slave successfully connects or pairs with a BT master they synchronize their frequency hopping pattern. If a master has not connected to a slave over a long period of time then the frequency hopping pattern can become severely out of sync. Variations in clock drift across Shimmers means that some Shimmers will become out of sync more easily than others. Note that, once a connection is made, the frequency pattern of the master and slave are, once again, synchronised.

### ***Shimmer Battery Performing Poorly***

If you are achieving poorer performance from your battery than expected, it may be that your battery has gone into a deep battery discharge state. To rectify this you should do the following:

- Install the sleep or blink firmware image. These firmware images are bundled with the Consensys software application and can be found on the "Other" tab in the "Firmware Selection" dialog.
- Charge unit for 6-7 hours (no longer). Remove from charger. Repeat charge for 6-7 hours.
- Install *LogAndStream* firmware and have a look at the battery voltage data to ensure that the battery is fully charged.
- Plot the battery voltage data vs. time as this gives an insight into how rapidly the battery is discharging.

If the battery is still faulty, please refer to the battery replacement information in *Section 3.5.3* of this document.

### ***PC cannot access SD card via Dock***

If you experience difficulties accessing the microSD card, please consult the Troubleshooting section of the *Shimmer Dock User Guide (v1.5 or later)* which can be obtained from the folder `\Documentation\Hardware User Guides` in the *Shimmer User Resources* distribution or from our website.

### ***Magnetometer value jumps to -4096***

Why does a Shimmer3 magnetometer axis sometimes read as -4096?

In the event of a data overflow on a magnetometer axis - as would be the case if the local magnetic field strength exceeds the configured magnetometer range - the axis channel will read as a value of -4096 in 2s complement form. To overcome this, simply increase the magnetometer range.

## 8. References

- [1] Bluetooth Special Interest Group, Serial port Profile Specification, Vol. 7 Part B of the Bluetooth Specification Version 2, November, 2004.
- [2] C. Hodgdon, Adaptive frequency hopping for reduced interference between Bluetooth and wireless LAN, Ericsson Technology Licensing, May 2003.
- [3] Roving Networks, Bluetooth Module RN-42, Available at <http://www.rovingnetworks.com>
- [4] Roving Networks, Bluetooth Module RN-46 Command Set, Available at <http://www.rovingnetworks.com>

## 9. Appendices

### 9.1. Appendix A - Mainboard detail for Debug and Testing

#### 9.1.1. Important Components

These following components may be removed or replaced to support specific user applications, configure the board or perform power-measurement testing. Figure 9-1 and Figure 9-2 provide illustrations of the *Shimmer3 mainboard* layout with each component labelled appropriately. For more information, contact Shimmer support.

J1	Negative battery terminal
J2	Positive battery terminal
F1	Battery discharge limit PTC (MF-FSMF050X-2)
SW2	On/Off switch
U9	Primary Regulator (3.0V LDO)
EU5	Battery charger
R37	Battery charger RSET
D5	Battery Isolation Diode (SBR130S3)
R46	Battery voltage divider resistor (top)
R47	Battery voltage divider resistor (bottom)
U1	Battery voltage divider buffer
X1	32.768k crystal
X3	XT2 clock source, 8MHz resonator
U8	CPU (MSP430F5437AIPN)
U2	Bluetooth soft power switch
U3	microSD power switch
U4	FFC / Radio Peripheral power switch
U5	TCXO power switch
EU1	RN-42 Bluetooth Radio Module
R20	Zero-ohm microSD power jumper (use for power measurements)
R21	Zero-ohm Radio power jumper (use for power measurements)
R23	Zero-ohm FFC / Radio peripheral power jumper (use for power measurements)
R41	22.1 ohm TCXO power jumper (use for power measurements and filtering)
R26	22.1 ohm MPU power jumper (use for power measurements and filtering)
R24	22.1 ohm low-noise accel. power jumper (use for power measurements and filtering)
U20	3-Axis low-noise accelerometer (KXRBS5-2042)
U21	6 Axis Motion Processor (MPU-9150)
U22	3-Axis magnetic sensor (LSM303DLHC)
U7	Digital Pressure/Temp Sensor (BMP180)
C44	.033uF Accelerometer x-filter
C26	.033uF Accelerometer y-filter
C29	.033uF Accelerometer z-filter
J6	Internal Expansion (BM10NB(0.6)-20DS-0.4V(51))
J7	Internal Expansion (BM10B(0.6)-20DP-0.4V(51))
J5	External Expansion (ST80-18P)
J8	FFC / Radio Peripheral Expansion (XF2L-1025-1A)
J4	microSD socket
U12	Debug Mode Mux (ADG784A)
U14,U15	microSD Isolation MUX (ADG742BKSZ)
U6	Debug Mode detector (MIC845HBC5)
SW1	User button
D1	Green LED
D2	Yellow LED
D3	Red LED
D6	Green LED
D9	Blue LED

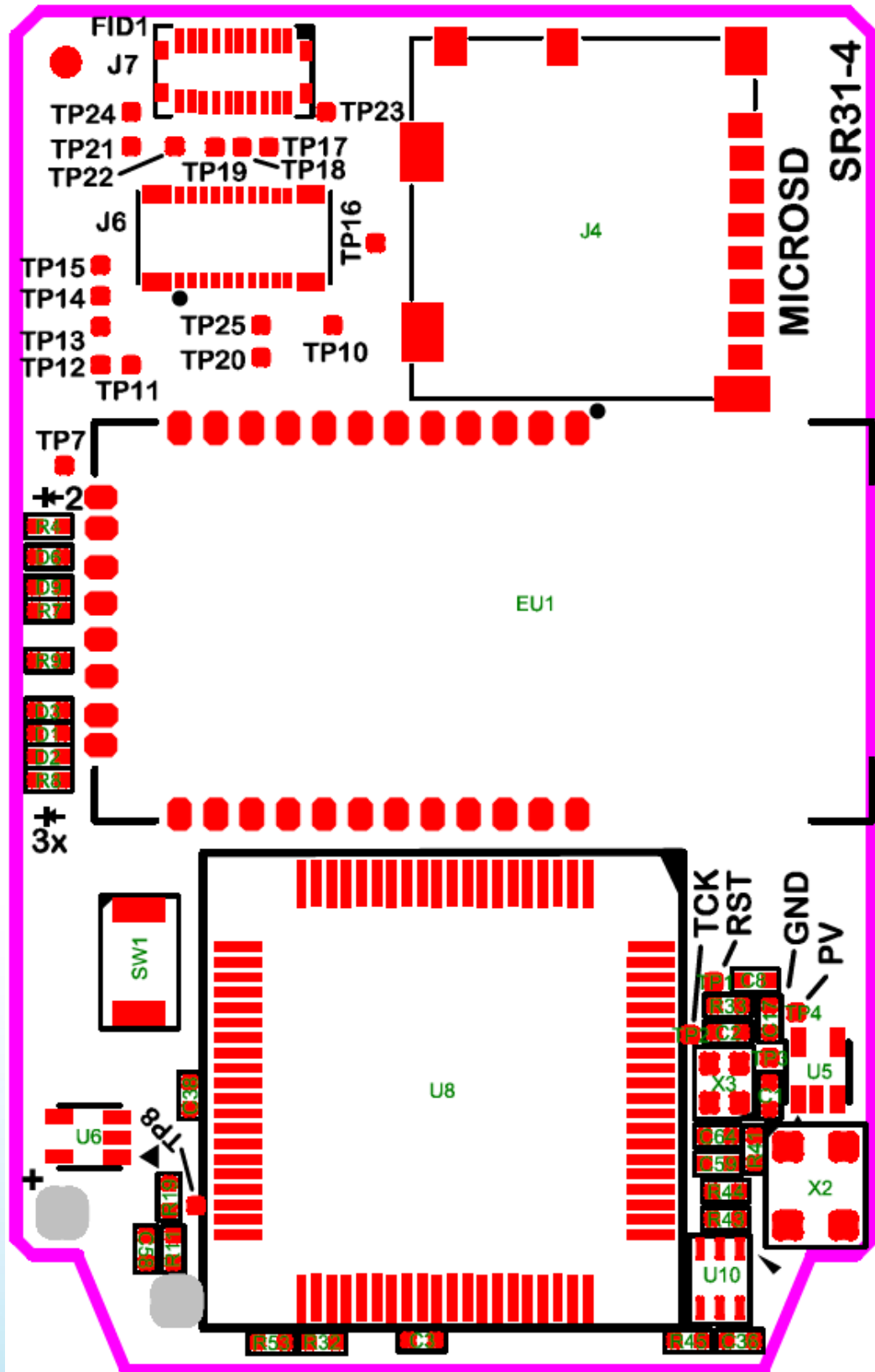

Figure 9-1 Shimmer3 mainboard Layout Top View



## 9.1.2. Connector Pin Assignments

### External Expansion Connector

Conn Pin	Net Name	Interruptible?	Function
J5-1	PV_CHG	N	Battery Charging Power 5-6VDC. Do not exceed 300mA connector current rating When >5.7V is applied to this pin, DEBUG mode is activated and JTAG signals are activated. JTAG signals are indicated in ( )'s below.
J5-2	SA_SOMI_RXD	N	USART A0: Serial
J5-3	SA_SIMO_TXD	N	USART A0: Serial
J5-4	FLASH_SCLK_EXT	N	USART B1: SPI (wired to microSD)
J5-5	FLASH_SOMI	N	USART B1: SPI (wired to microSD)
J5-6	FLASH_SIMO	N	USART B1: SPI (wired to microSD)
J5-7	SBWTCK	N	BSL programming
J5-8	MSP_RESET_N	N	BSL programming and Global Reset
J5-9	DETECT_N (JTAG_TDI)	N	Card detect output signal to flash controller (JTAG TDI signal)
J5-10	GPIO_EXTERNAL_RADIO_DD	Y	GPIO. Alternate function is reserved for coprocessor Bi-Spy Wire
J5-11	BSL_RX_LED_BLU (JTAG_TMS)	Y	BSL programming, BLU LED SIGNAL (JTAG TMS signal)
J5-12	ADC6_FLASHDAT2	N	ADC input or GPO. Also used for SD mode flash access
J5-13	ADC7_FLASHDAT1	N	ADC input or GPO. Also used for SD mode flash access
J5-14	BSL_TX_LED_GR1 (JTAG_TCK)	Y	BSL Programming, LED signal (JTAG_TCK signal)
J5-15	FLASH_CS_N (JTAG_TDO)	Y	Flash CS or SD Mode DAT3 line (JTAG TDO Signal)
J5-16	ADC15_RADIO_DC	Y	ADC Input. Alternate function is reserved for coprocessor Bi-Spy Wire
J5-17	PV	N	Regulated Board power output: 3.0VDC @ 100ma*
J5-18	GND	N	Board Ground
J5-TABS/SHELL	GND	N	Board Ground

Table 9-1 External Expansion Connector Pin Assignment

\* Exact current capacity will vary based on operating state of integrated peripherals and processor.



## Internal Expansion Connectors

For function descriptions see previous table.

Conn and Pin Number	Net Name	Conn and Pin Number	Net Name
J6-1 J6-20	PV	J7-1 J7-2	PV_REG
J6-2 J6-19	GPIO_INTERNAL2	J7-19 J7-20	
J6-3 J6-18	GPIO_INTERNAL	J7-3 J7-18	ADC1
J6-4 J6-17	SA_SIMO_TXD	J7-4 J7-17	ADC12
J6-5 J6-16	SA_SOMI_RXD	J7-5 J7-16	ADC13
J6-6 J6-15	SA_SCLK	J7-6 J7-15	ADC14
J6-7 J6-14	SB_SCL	J7-7 J7-14	GPIO_INTERNAL1
J6-8 J6-13	SB_SDA	J7-8 J7-13	EXP_RESET_N
J6-9 J6,10 J6-11 J6-12	GND	J7-9 J7,10 J7-11 J7-12	GND
J6-TABS	GND	J7-TABS	GND

Table 9-2 Internal Expansion Connector Pin Assignment

### 9.1.3. CPU Pin Assignment

The CPU pin connections for Shimmer developers are listed below:

Pin Name	Pin #	Board Name	Use	Type
DVCC	16,51,31,67	PV_MSP	Power	Analogue
AVCC	11	PV_MSP	Power	Analogue
VREF	9	PV_VREF_MSP	A/D Ref	Analogue
VREFN	10	GND	A/D Ref	Analogue
DVSS	15,50,30,68	GND	Power	Analogue
AVSS	12	GND	Power	Analogue
VCORE	11	PV_MSPC	Power	Analogue
TEST	71	SBWTCK	BSL, SBW	Input
TCK	75	JTAG_TCK	JTAG	Input
TMS	74	TP_JTAG_TMS	JTAG	
TDI	73	TP_JTAG_TDI	JTAG	
TDO	72	TP_JTAG_TDO	JTAG	
RST_N	76	MSP_RESET_N	BSL, SBW, JTAG	Open Drain
XIN	13	CLK_MSP_XIN	Primary XTAL	Clocking
XOUT	14	CLK_MSP_XOUT	Primary XTAL	Clocking
XT2IN	69	CLK_MSP_HF_XIN	8MHz Resonator	Clocking
XT2OUT	70	CLK_MSP_HF_XOUT	8MHz Resonator	Clocking
P1.0	17	RADIO_STATUS	RADIO, RADIO EXP	Input (IRQ)
P1.1	18	BSL_TX_LED_GR1	BSL/LED	Output
P1.2	19	BSL_RX_LED_BLU	BSL/LED	
P1.3	20	RADIO_RTS	RADIO	INPUT(IRQ)

P1.4	21	GPIO_INTERNAL	TBD	Input (IRQ)
P1.5	22	GPIO_EXTERNAL_RADIO_DD	TBD, RADIO EXP	Input (IRQ)
P1.6	23	USER_N	User Button	Input (IRQ)
P1.7	24	MPU_INT	Kinematics	Input(IRQ)
P2.0	25	GPIO_EXTERNAL1	Expansion	Input (IRQ)
P2.1	26	GPIO_EXTERNAL2	Expansion	Input (IRQ)
P2.2	27	RADIO_CTS	RADIO	Input (IRQ)
P2.3	28	DOCK		Input (IRQ)
P2.4	29	MAG_DRDY	Kinematics	Input (IRQ)
P2.5	32	MAG_INT1	Kinematics	Input (IRQ)
P2.6	33	CHG_STAT1	CHARGER	Input (IRQ)
P2.7	34	CHG_STAT2	CHARGER	Input (IRQ)
P3.0	35	SA_SCLK_R	Expansion	Output
P3.1	36	SB_SDA	USART B0	Output
P3.2	37	SB_SCL	USART B0	Input
P3.3	38	EXP_RESET_N	Expansion	Output
P3.4	39	SA_SIMO_TXD	USART A0	Output
P3.5	40	SA_SOMI_RXD	USART A0	Input
P3.6	41	RADIO_SCLK_R	RADIO EXP, USART A1	Output
P3.7	42	FLASH_SIMO	FLASH, USART B1	Output
P4.0	43	FLASH_CS_N_FLASH_DAT3	FLASH	Output
P4.1	44	SD_DETECT_N	FLASH	Input
P4.2	45	SW_FLASH	FLASH	Output
P4.3	46	SW_BT	RADIO	Output
P4.4	47	BT_RESET_N	RADIO	Output
P4.5	48	BT_FACTORY	RADIO	Output
P4.6	52	SW_TCXO	TCXO	Output
P4.7	53	TCXO_CLK_R	TCXO	Input (Clock)
P5.4	54	FLASH_SOMI	FLASH	Input
P5.5	55	FLASH_SCLK_R	FLASH	Output
P5.6	56	RADIO_TXD_SIMO	RADIO, RADIO EXP	Output
P5.7	57	RADIO_RXD_SOMI	RADIO, RADIO EXP	Input
P7.2	58	LED_RD	LED	Output
P7.3	59	LED_GR	LED	Output
P8.0	60	LED_YE	LED	Output
P8.1	61	RADIO_CS_N	RADIO EXP	Output
P8.2	62	RADIO_RESET_N	RADIO EXP	Output
P8.3	63	SW_RADIO	RADIO EXP	Output
P8.4	64	NOT ROUTED		
P8.5	65	NOT ROUTED		
P8.6	66	SW_ACCCEL	Kinematics	Output
P6.0	77	DETECT_N	FLASH	Output
P6.1	78	SEL_ADC	Expansion	Output
P6.2	79	BATTERY	ADC	Analogue Input
P6.3	80	ACCEL_X	Low Noise Accel	Analogue Input
P6.4	1	ACCEL_Y	Low Noise Accel	Analogue Input
P6.5	2	ACCEL_Z	Low Noise Accel	Analogue Input
P6.6	3	ADC6_FLASHDAT2	Ext GPIO, ADC	Analogue Input
P6.7	4	ADC7_FLASHDAT1	Ext GPIO, ADC	Analogue Input
P7.4	5	ADC12	ADC	Analogue Input
P7.5	6	ADC13	ADC	Analogue Input
P7.6	7	ADC14	ADC	Analogue Input
P7.7	8	ADC15_RADIO_DC	ADC, RADIO EXP	Analogue Input

#### 9.1.4. Shimmer Clock Drift

Like many embedded devices, the clock on the Shimmer device is prone to drift. Laboratory experiments have indicated that Shimmer-to-Shimmer clock drift is variable and can be up to 12  $\mu\text{s/s}$ . To equate this to longer recording periods 12 $\mu\text{sec/sec}$  is equivalent to 0.72 ms/min, 43 ms/hour and 1.04 s/day.

## 9.2. Appendix B - Legacy Support

### 9.2.1. Legacy Support

*Shimmer1*, *Shimmer2*, and *Shimmer2R* daughter boards and applications are not compatible with *Shimmer3*.

Dock and Charging Peripherals may be used for charging and, in some cases, firmware updates. Flash access is not supported using legacy docks.

## 9.3. Appendix C – Opening or assembling the *Shimmer3* enclosure

Whilst the *Shimmer3* enclosure can be opened to allow hardware reconfiguration of the device (e.g. adding an expansion board), it is important to note that the plastic enclosure is not designed for regular opening and closing. In particular, it is recommended that the screws not be removed and reinserted on a regular basis as damage to the plastic by over-use of the screw mechanism will occur.

***Please, consider your configurations carefully to minimise the number of hardware reconfigurations you will need to carry out.***

The following instructions should be used as a guide for opening and closing the *Shimmer3* enclosure.

### 9.3.1. Opening the enclosure to change the SD card or insert an expansion board

1. Unscrew the screws using a T6 screwdriver.
2. Turn the unit over so that the button is facing up.
3. Carefully remove the top of the case, opening from the end of the dock connector.
4. You now have access to the SD card slot and the internal expansion connector.
5. If, for any reason you need to remove the circuit board from the case, lift it upward out of the case. The battery should be attached to the underside of the board – ensure that it comes out of the case with the board so as not to damage the connections.



Figure 9-3 Opening the enclosure

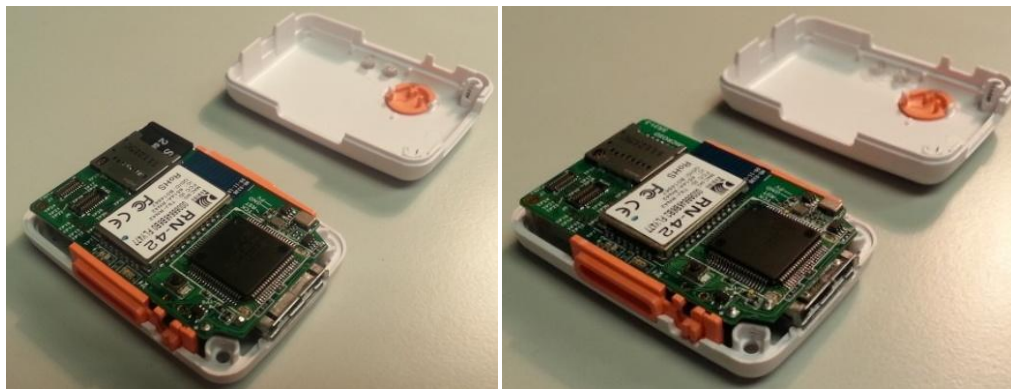

Figure 9-4 Open enclosure with (left) and without (right) SD card

### 9.3.2. Assembling the enclosure

1. Ensure that you have all of the required plastic parts as shown in Figure 9-5, as well as two screws (M2.0 x 8mm).
2. Assemble the orange clip fittings in the bottom of the enclosure (these are both the same so it doesn't matter which one goes to which side).
3. Install the power switch cap, as shown in Figure 9-6.
4. Place the circuit board, with the battery attached to the underside, into the bottom of the enclosure, as shown in Figure 9-7.
  - The bottom of the enclosure has a plastic divider to hold the battery in place; ensure that the battery is fitted beside this divider.
  - Ensure that the power switch actuator sits in the notch on the power switch cap and that the dock connector sits neatly into its slot.
  - Ensure that the battery wires are fully underneath the circuit board and not obstructing the screw positions.
  - The orange clip fittings are designed to hold the circuit board in place – it should be an exact fit.
5. Insert the SD card, as shown in Figure 9-7.
6. Carefully attach the top of the case, starting from the end of the dock connector, as shown in Figure 9-8. When the top is in place, gently push down on the top to snap closed.
  - Do not force the top closed – if there is an obstruction, remove the top to clear the obstruction before trying again.
7. Tighten the screws in the underside of the enclosure.

- **Note:** it is very important to hold the boss ends together while running in the screw. Do not let the screws draw the parts together as this could damage the enclosure.
- **Note:** do not over-tighten the screws as they may damage the top of the enclosure; when the top of the screw is flush with the plastic, stop tightening.



Figure 9-5 Plastic enclosure parts

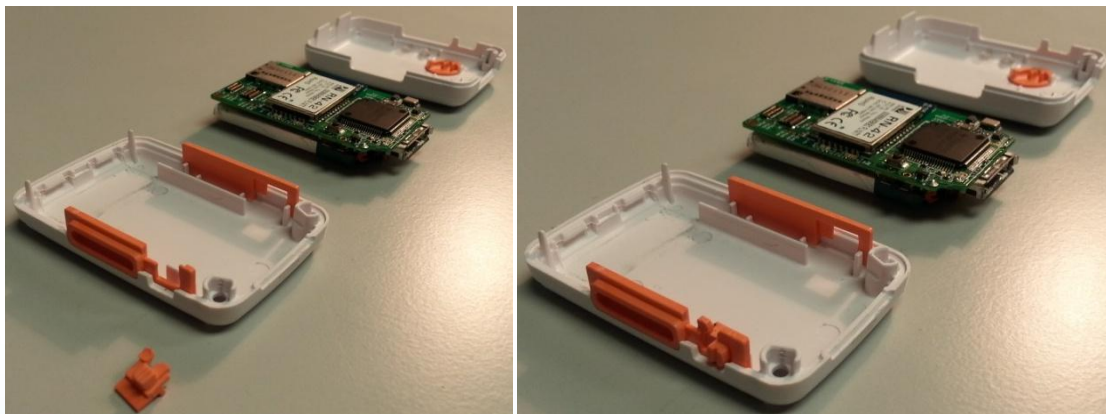

Figure 9-6 Assembling clip fittings and power switch cap



Figure 9-7 Installed circuit board and SD card insertion





*Figure 9-8 Closing the enclosure and inserting screws*

## Glossary

ACLK	Auxiliary Clock
ADC	Analogue-to-Digital Converter
BSL	Boot Strap Loader
BT	Bluetooth
CPU	Central Processing Unit
CSMA	Carrier Sense Multiple Access
CVS	Concurrent Versioning System
DCO	Digitally Controlled Oscillator
DMA	Direct Memory Access
ECG	Electrocardiogram
ECG	Electrocardiogram
EEG	Electroencephalogram
EMG	Electromyogram
EOG	Electrooculography
FHSS	Frequency Hopping Spread Spectrum
GPIO	General Purpose Input/Output
GSR	Galvanic Skin Response
GUI	Graphical User Interface
HTML	Hypertext Markup Language
HTTP	Hypertext Transfer Protocol
ID	Instrument Driver
IEEE	Institute of Electrical and Electronic Engineers
ISM	Industrial, Scientific and Medical Band
LCD	Liquid Crystal Display
LED	Light Emitting Diode
MAB	Memory Address Bus
MAC	Media Access Control
MCLK	Master Clock
MDB	Memory Data Bus
MPR	Microprocessor and Radio Boards
MSS	Multi-Shimmer Sync
MTS	Mote Sensor
nesC	network embedded system C
PAN	Personal Area Network
PWM	Pulse Width Modulation
RAM	Random Access Memory
RF	Radio Frequency
RISC	Reduced Instruction Set Computer
ROM	Read Only Memory
RPM	RedHat Package Manager
SD	Secure Digital
SDK	Software Development Kit
SIG	Special Interest Group
SIMO	Slave In, Master Out
SIP	Session Initiation Protocol
SMCLK	Sub-Main Clock
SOMI	Slave Out, Master In
SPI	Serial Peripheral Interface
SPP	Serial Port Profile
STE	Slave Transmit Enable
TCP/IP	Transmission Control Protocol / Internet Protocol
TinyOS	Tiny Operating System
UART	Universal Asynchronous Receiver/Transmitter
UCLK	USART Clock
USART	Universal Serial Asynchronous Receiver/Transmitter
USB	Universal Serial Bus
WBSN	Wireless Based Sensor Network
WSN	Wireless Sensor Network



# WE MAKE IT HAPPEN - INNOVATION REALIZED

Shimmer provides advanced development of wearable sensing systems. We bring your idea from concept to launch, delivering sensing innovations that matter.

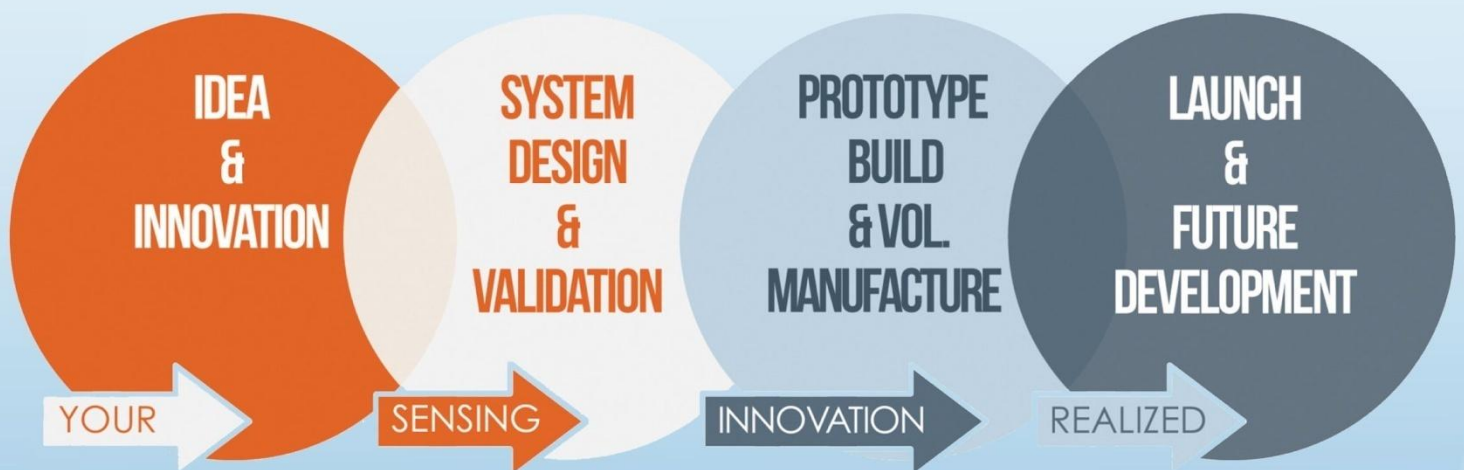

## HOW WE OFFER IT

We offer consultancy, contract and manufacturing services, all the way through to a dedicated development team. This allows for the understanding and insight that accelerates your innovation's development, and reduces your cost and time to market by up to 80%.

### Shimmer International Offices:

Europe – Dublin, Ireland.

USA – Boston, MA.

Asia – Kuala Lumpur, Malaysia.

**Web:** [www.ShimmerSensing.com](http://www.ShimmerSensing.com)

**Email:** [InnovationRealised@ShimmerSensing.com](mailto:InnovationRealised@ShimmerSensing.com)

 [www.Shimmersensing.com](http://www.Shimmersensing.com)

 /ShimmerResearch

 @ShimmerSensing

 /company/Shimmer

 /ShimmerSensing

 /ShimmerResearch